

VEVOR[®]

TOUGH TOOLS, HALF PRICE

Technical Support and E-Warranty Certificate www.vevor.com/support

YURT TENT USER MANUAL

We continue to be committed to provide you tools with competitive price.

"Save Half", "Half Price" or any other similar expressions used by us only represents an estimate of savings you might benefit from buying certain tools with us compared to the major top brands and does not necessarily mean to cover all categories of tools offered by us. You are kindly reminded to verify carefully when you are placing an order with us if you are actually saving half in comparison with the top major brands.

VEVOR[®]

TOUGH TOOLS, HALF PRICE

YURT TENT

Model: ZJTM1009, ZJTM1149, ZJTM1215, ZJTM1303, ZJTM1304

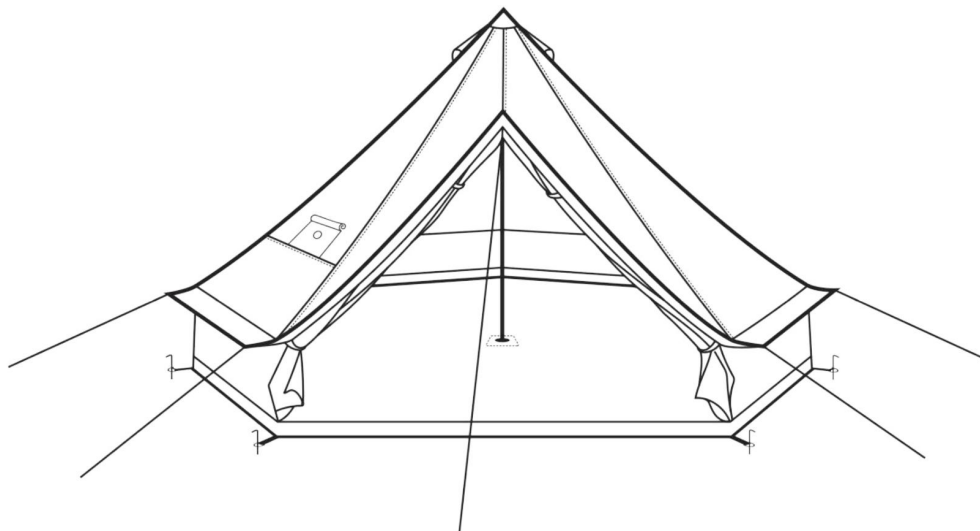

NEED HELP? CONTACT US!

Have product questions? Need technical support? Please feel free to contact us:

Technical Support and E-Warranty Certificate
www.vevor.com/support

This is the original instruction, please read all manual instructions carefully before operating. VEVOR reserves a clear interpretation of our user manual. The appearance of the product shall be subject to the product you received. Please forgive us that we won't inform you again if there are any technology or software updates on our product.

SPECIFICATIONS

Model	ZJTM1009	
Product Size	Diameter: 3m Height: 2m Height of Door: 1.5m Height of fence: 0.6m	
Color	Beige	

Model	ZJTM1149	
Product Size	Diameter: 4m Height: 2.5m Height of Door: 1.5m Height of fence: 0.6m	
Color	Beige	

Model	ZJTM1215	
Product Size	Diameter: 5m Height: 3m Height of Door: 1.7m Height of fence: 0.6m	
Color	Beige	

Model	ZJTM1303	
Product Size	Diameter: 6m Height: 3.5m Height of Door: 1.7m Height of fence: 0.6m	
Color	Beige	

Model	ZJTM1304	
Product Size	Diameter: 7m Height: 3.5m Height of Door: 1.9m Height of fence: 0.7m	
Color	Beige	

! CAUTIONS

1. Please refer to parts list to check items you received carefully, do not discard any of the packaging until you have checked that you have all the parts & hardware! Don't hesitate to contact us if you missed parts, have broken parts or have any other installation problems.
2. Select a level site clear of rocks, branches, and other hard or sharp objects to install your tent and be sure that no underground utilities are present. Do not set up your tent under trees or tall buildings to avoid potential safety hazards caused by falling objects.
3. The tent is manufactured for use as a temporary structure and does not meet structural code, the installer is responsible for anticipating weather severity for the proper time of installation.
4. As the tent needs to be fixed at any time during the building process, enlist at least one person to assist you when it is time to assemble the tent.
5. The warnings, cautions, and instructions discussed in this instruction manual cannot cover all possible conditions. We will not be responsible for any damage caused by human factors. If there is any problem during the use of the product, please contact us in time.

! WARNING

1. Keep away from children, the elderly and other people to prevent personal injury caused by falling metal frames during installation.
2. Keep all flame and heat sources away from this tent fabric to avoid the tent burning by accidental contact.

! CARE INSTRUCTION

1. Clean debris and Keep the canvas dry when storing the tent, store the metal frame and canvas separately in the carry bag to prevent mildew or damage.
2. Use normal detergent and water for cleaning if the tent is dirty.

! PRECAUTIONS







The following precautions should be taken when you go outdoors:

1. Be certain that your tent is properly ventilated (especially if you decide to ignore the first warning and use a heater in your tent). Carbon monoxide is real, and can cause serious damage such as death. Vents and screens are built into the tent body.
2. Be sure to anchor your tent properly—this is not a free-standing tent—follow these instructions for proper staking practices and ensure that all guy lines & pegs are securely fixed.
3. Be certain that children are supervised in and around the tent at all times.
4. Do not use candles, matches or open flames of any kind in or near a tent.
5. It is better to not cook inside a tent, but if you are, do not leave cooking unattended. Make sure grills, cooking appliances and similar must not be placed nearer than 1 meter to tent canvas. There should be no use of open fires or glowing charcoal inside tents or near tent canvas - fire can spread very quickly. There should be no use of open fires or glowing charcoal inside tents or near tent canvas as there is a significant risk from the buildup of Carbon Monoxide (CO), particularly in a confined space inside the tent. All flexible tubes and couplings to the gas burner should be checked for leakage and that it is in good order.
6. Build campfires downwind and several meters away from a tent and be sure to fully extinguish campfires before leaving a campsite or before retiring for the night.
7. Exercise extreme caution when using fuel-powered lanterns or heaters inside a tent and use battery-operated lanterns whenever possible. Do not refuel lamps, heaters or stoves inside a tent. Extinguish or turn off all lanterns before going to sleep.
8. Do not smoke in a tent or store flammable liquids inside a tent. Installation of log burners or heating equipment at your own risk.

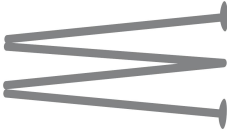
SAVE THESE INSTRUCTIONS

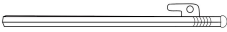

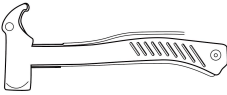
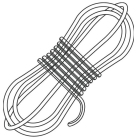



Model :ZJTM1009(Diameter: 3m)

PARTS LIST

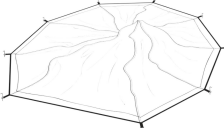
NO.	NAME	DRAWING	QTY
1	Bell tent		1
2	Center pole		1
3	A-frame door pole		1
4	Stake A		10
5	Stake B		10
6	Hammer		1
7	Guy rope		10
8	Rain cap		1



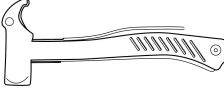
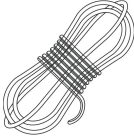



Model :ZJTM1149(Diameter: 4m)

PARTS LIST

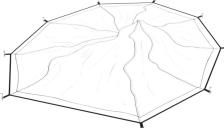

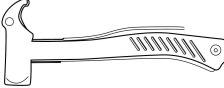
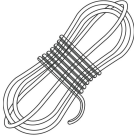

NO.	NAME	DRAWING	QTY
1	Bell tent		1
2	Center pole		1
3	A-frame door pole		1
4	Stake A		12
5	Stake B		12
6	Hammer		1
7	Guy rope		12
8	Rain cap		1

Model : ZJTM1215(Diameter: 5m)

PARTS LIST

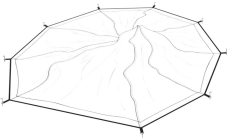
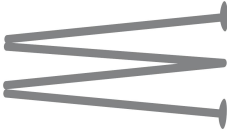
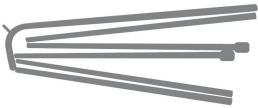
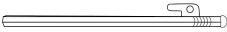

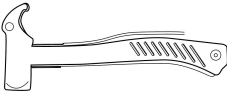
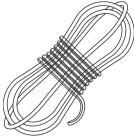



NO.	NAME	DRAWING	QTY
1	Bell tent		1
2	Center pole		1
3	A-frame door pole		1
4	Stake A		12
5	Stake B		12
6	Hammer		1
7	Guy rope		12
8	Rain cap		1

Model :ZJTM1303(Diameter: 6m)**PARTS LIST**

NO.	NAME	DRAWING	QTY
1	Bell tent		1
2	Center pole		1
3	A-frame door pole		1
4	Stake A		14
5	Stake B		14
6	Hammer		1
7	Guy rope		14
8	Rain cap		1

Model :ZJTM1304(Diameter: 7m)

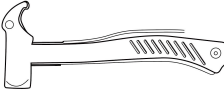
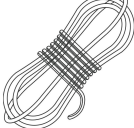
PARTS LIST

NO.	NAME	DRAWING	QTY
1	Bell tent		1
2	Center pole		1
3	A-frame door pole		1
4	Stake A		16
5	Stake B		16
6	Hammer		1
7	Guy rope		16
8	Rain cap		1

ASSEMBLY INSTRUCTION

STEP 1

Fix the tent body

- Lay your tent onto the ground, keep the floor taut with partner. Stake down 10 tent corners with the stake B.

Stake B

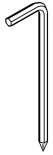

Hammer

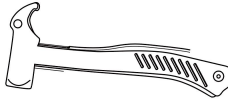

! NOTE:

Please don't stake down too much at this step for later adjustment.

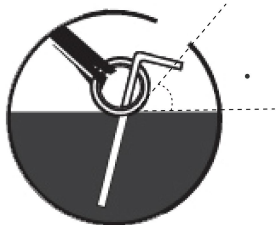
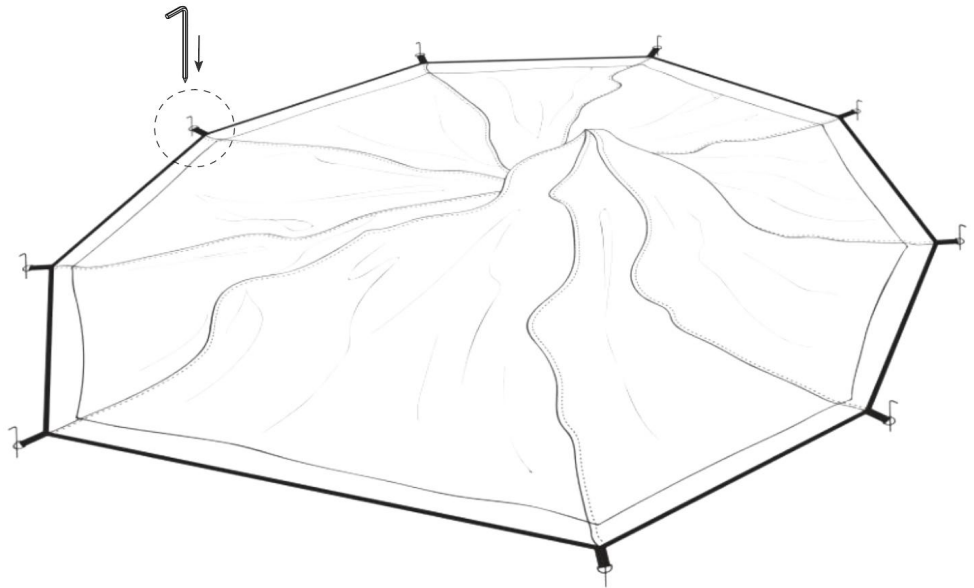

The stake maintain an angle of 45° - 60° with the ground, so the angle of bearing capacity is the largest.

STEP 2

Prop up the tent

- Assemble the center pole through the built-in metal buckle.

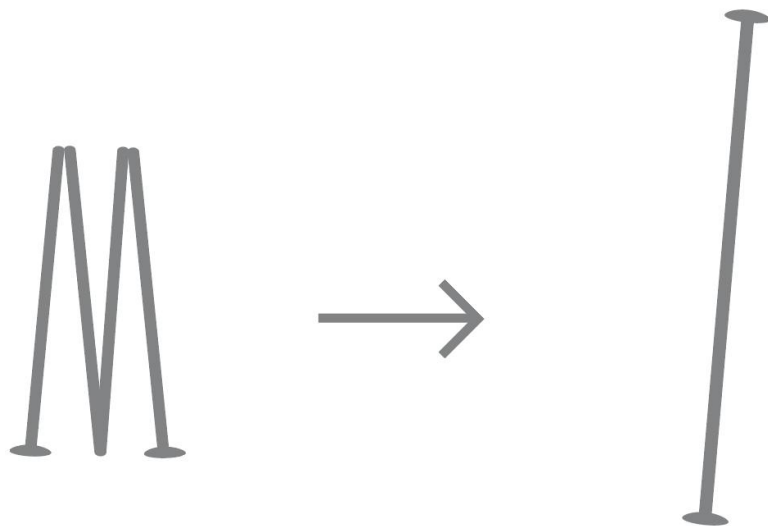

- One person put centre pole on the middle point of floor for propping up the tent.

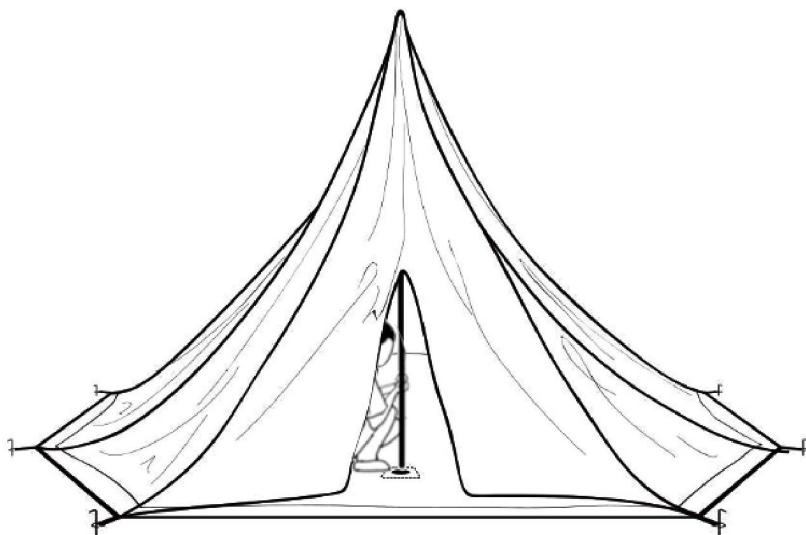

STEP 3

Install door pole

- Partner put A-frame door pole through the ring of door top, then insert feet of door pole into the pockets on underside of door.

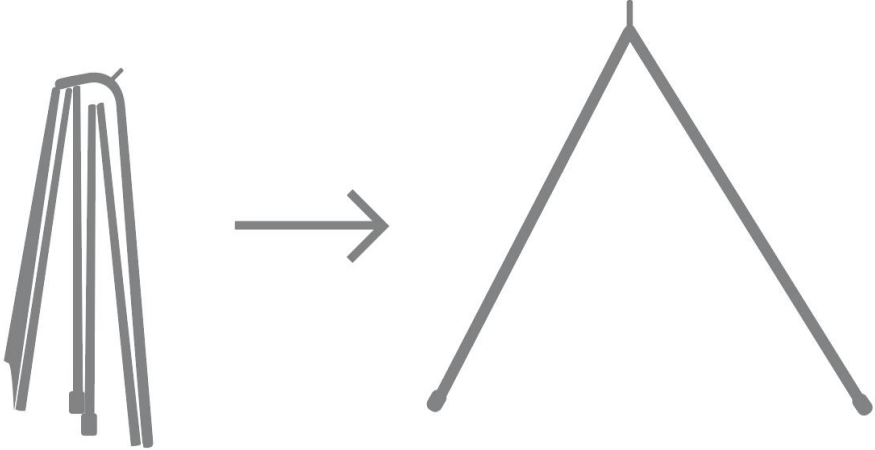

- Attach rain cap on the top of A-frame door pole.

(Make adjustments to the stake B after this step, if needed.)

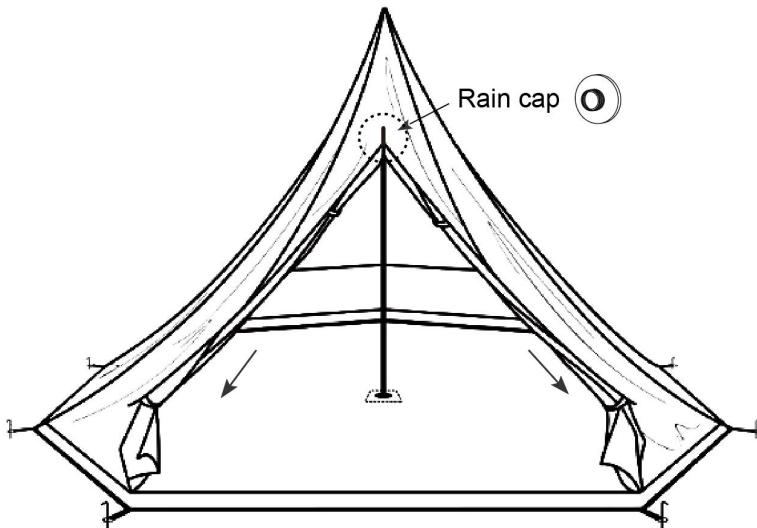

STEP 4

Finish the tent assembly

- Fix 12 guy ropes with stake A around the tent and straighten them.

Recommend pulling out guy ropes along the direction of every seam on the tent roof to get the perfect visual effect and stability.

(Make adjustments to the tent stakes after this step, if needed.)

Stake A

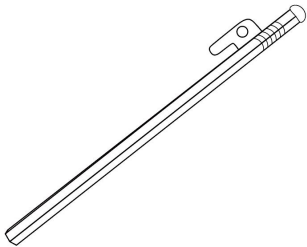

Hammer

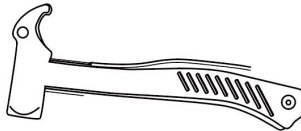

Guy rope

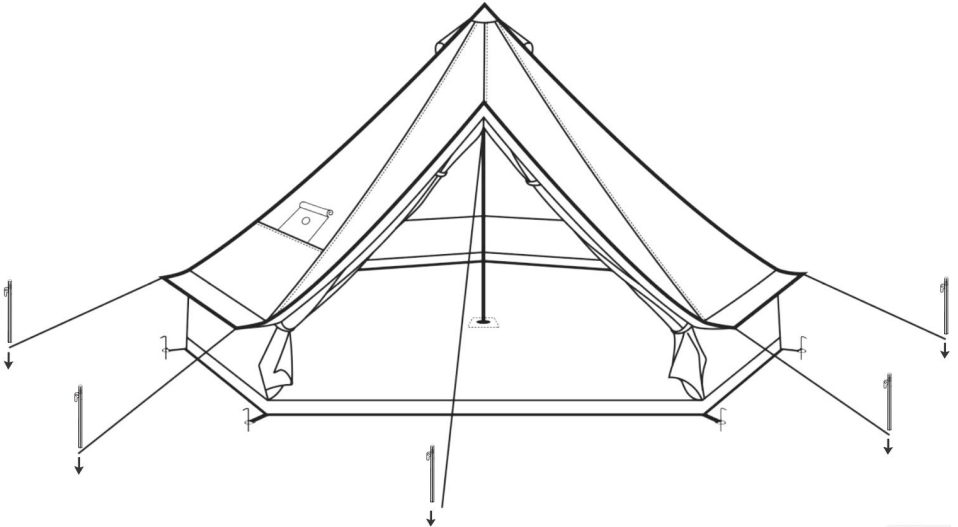
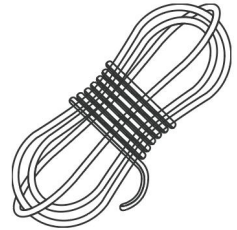

NOTE: Use the longest rope (the rope buckle with different color) to secure the tent door.

Address: Baoshanqu Shuangchenglu 803long 11hao 1602A-1609shi Shanghai

Imported to AUS: SIHAO PTY LTD.1 ROKEVA STREETEASTWOOD NSW 2122 Australia

Imported to USA: Sanven Technology Ltd.Suite 250, 9166 Anaheim Place, Rancho Cucamonga, CA 91730

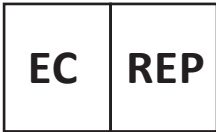

SHUNSHUN GmbH
Römeräcker 9 Z2021,76351
Linkenheim-Hochstetten,Germany



Pooledas Group Ltd
Unit 5 Albert Edward House, The Pavilions
Preston, United Kingdom

Made In China

VEVOR[®]

TOUGH TOOLS, HALF PRICE

Technical Support and E-Warranty Certificate

www.vevor.com/support

VEVOR[®]

TOUGH TOOLS, HALF PRICE

Technique Assistance et certificat de garantie électronique

www.vevor.com/support

TENTE YOURTE MANUEL DE L'UTILISATEUR

We continue to be committed to provide you tools with competitive price.

"Save Half", "Half Price" or any other similar expressions used by us only represents an estimate of savings you might benefit from buying certain tools with us compared to the major top brands and does not necessarily mean to cover all categories of tools offered by us. You are kindly reminded to verify carefully when you are placing an order with us if you are actually saving half in comparison with the top major brands.

VEVOR®

TOUGH TOOLS, HALF PRICE

YURT TENT

Modèle : ZJTM1009, ZJTM1149, ZJTM1215, ZJTM1303,
ZJTM1304.

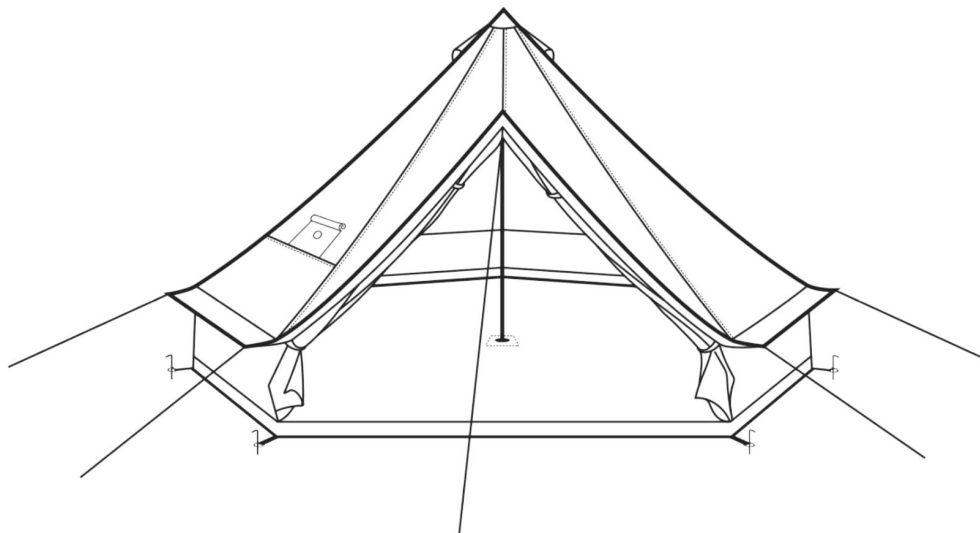

NEED HELP? CONTACT US!

Have product questions? Need technical support? Please feel free to contact us:

Technical Support and E-Warranty Certificate
www.vevor.com/support

This is the original instruction, please read all manual instructions carefully before operating. VEVOR reserves a clear interpretation of our user manual. The appearance of the product shall be subject to the product you received. Please forgive us that we won't inform you again if there are any technology or software updates on our product.

CARACTÉRISTIQUES

Modèle	ZJTM1009	
Taille du produit	Diamètre : 3m _ Hauteur : 2m Hauteur de la porte : 1,5m Hauteur de clôture : 0,6m	
Couleur	Beige	

Modèle	ZJTM1149	
Taille du produit	D iamètre : 4m Hauteur : 2,5m Hauteur de la porte : 1,5m Hauteur de clôture : 0,6m	
Couleur	Beige	

Modèle	ZJTM1215	
Taille du produit	D iamètre : 5m Hauteur : 3m Hauteur de la porte : 1,7m Hauteur de clôture : 0,6m	
Couleur	Beige	

Couleur	Beige	
---------	-------	--

Modèle	ZJTM1303	
Taille du produit	Diamètre : 6m _ Hauteur : 3,5m Hauteur de la porte : 1,7m Hauteur de clôture : 0,6m	
Couleur	Beige	

Modèle	ZJTM1304	
Taille du produit	Diamètre : 7m _ Hauteur : 3,5m Hauteur de la porte : 1,9m Hauteur de clôture : 0,7m	
Couleur	Beige	

! PRÉCAUTIONS

6. Veuillez vous référer à la liste des pièces pour vérifier soigneusement les articles que vous avez reçus. Ne jetez aucun emballage avant d'avoir vérifié que vous disposez de toutes les pièces et du matériel ! N'hésitez pas à nous contacter si vous manquez des pièces, si vous avez des pièces cassées ou si vous avez tout autre problème d'installation.
7. Sélectionnez un site plat, exempt de roches, de branches et d'autres objets durs ou pointus pour installer votre tente et assurez-vous qu'aucun service souterrain n'est présent. N'installez pas votre tente sous des arbres ou des bâtiments de grande hauteur pour éviter les risques potentiels de sécurité causés par la chute d'objets.

8. La tente est fabriquée pour être utilisée comme structure temporaire et ne respecte pas le code de la structure. L'installateur est responsable d'anticiper les intempéries pour le moment approprié de l'installation.

9. Comme la tente doit être réparée à tout moment pendant le processus de construction, inscrivez-vous à au moins une personne pour vous aider au moment de monter la tente.

10. Les avertissements, mises en garde et instructions abordés dans ce manuel d'instructions ne peuvent pas couvrir toutes les conditions possibles. Nous ne serons pas responsables de tout dommage causé par des facteurs humains. S'il y a un problème lors de l'utilisation du produit, veuillez nous contacter à temps.

! AVERTISSEMENT

3. Tenir à l'écart des enfants, des personnes âgées et d'autres personnes pour éviter les blessures causées par la chute des cadres métalliques lors de l'installation.

4. Gardez toutes les sources de flammes et de chaleur éloignées de ce tissu de tente pour éviter que la tente ne brûle par contact accidentel.

! INSTRUCTION DE SOINS

3. Nettoyez les débris et gardez la toile au sec lors du stockage de la tente, rangez le cadre métallique et la toile séparément dans le sac de transport pour éviter la moisissure ou les dommages.

4. Utilisez un détergent normal et de l'eau pour le nettoyage si la tente est sale.

! PRÉCAUTIONS

Les précautions suivantes doivent être prises lorsque vous sortez à l'extérieur :

9. Assurez-vous que votre tente est bien ventilée (surtout si vous décidez d'ignorer le premier avertissement et d'utiliser un chauffage dans votre tente). Le monoxyde de carbone est réel et peut causer de graves dommages, voire la mort. Des bouches d'aération et des écrans sont intégrés au corps de la tente.

10. Assurez-vous d'ancrer correctement votre tente (il ne s'agit pas d'une tente autoportante), suivez ces instructions pour connaître les bonnes pratiques de jalonnement et assurez-vous que tous les haubans et piquets sont solidement fixés.

11. Assurez-vous que les enfants sont surveillés à tout moment dans et autour de la tente.

12. N'utilisez pas de bougies, d'allumettes ou de flammes nues de toute sorte dans ou à proximité d'une tente.

13. Il est préférable de ne pas cuisiner à l'intérieur d'une tente, mais si c'est le cas, ne laissez pas cuisiner sans surveillance. Assurez-vous que les grils, appareils de cuisson et



similaires ne doivent pas être placés à moins de 1 mètre de la toile de la tente. Il ne faut pas utiliser de feux ouverts ou de charbon de bois incandescent à l'intérieur des tentes ou à proximité de la toile de la tente - le feu peut se propager très rapidement. Il ne faut pas utiliser de feux ouverts ou de charbon de bois incandescent à l'intérieur des tentes ou à proximité de la toile de tente car il existe un risque important d'accumulation de monoxyde de carbone (CO), en particulier dans un espace confiné à l'intérieur de la tente. Tous les tubes flexibles et raccords du brûleur à gaz doivent être vérifiés pour détecter toute fuite et s'assurer qu'ils sont en bon état.





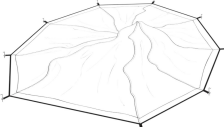

14. Allumez des feux de camp sous le vent et à plusieurs mètres d' une tente et assurez-vous d' éteindre complètement les feux de camp avant de quitter un camping ou avant de vous retirer pour la nuit.

15. Faites preuve d'une extrême prudence lorsque vous utilisez des lanternes ou des radiateurs à combustible à l'intérieur d'une tente et utilisez des lanternes à piles autant que possible. Ne faites pas le plein de lampes, de radiateurs ou de poêles à l'intérieur d'une tente. Éteignez ou éteignez toutes les lanternes avant de vous coucher.

16. Ne fumez pas dans une tente et ne stockez pas de liquides inflammables à l'intérieur d'une tente. Installation de poêles à bois ou d'équipements de chauffage à vos propres risques.

CONSERVEZ CES INSTRUCTIONS

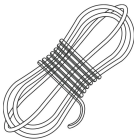



Modèle : ZJTM1009 (Diamètre : 3 m)			
LES PIÈCES LISTE			
NON.	NOM	DESSIN	QTÉ
1	Tente cloche		1
2	Poteau central		1

3	Cadre en A poteau de porte		1
4	Enjeu A		dix
5	Enjeu B		dix
6	Marteau		1
7	Corde de haubanage		dix
8	Bonnet de pluie		1

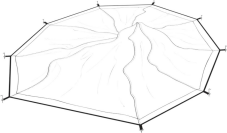
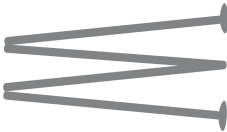
Modèle :ZJTM1149 (Diamètre : 4 m)

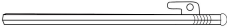
LES PIÈCES LISTE

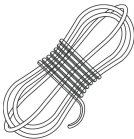



NON.	NOM	DESSIN	QTÉ
1	Tente cloche		1
2	Poteau central		1

3	Cadre en A poteau de porte		1
4	Enjeu A		12
5	Enjeu B		12
6	Marteau		1
7	Corde de haubanage		12
8	Bonnet de pluie		1

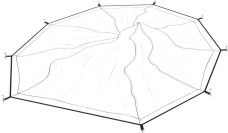
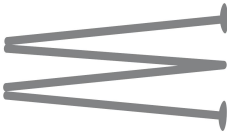
Modèle : ZJTM1215 (Diamètre : 5 m)

LES PIÈCES LISTE

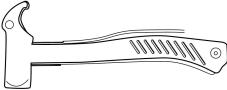
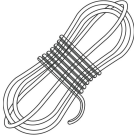



NON.	NOM	DESSIN	QTÉ
1	Tente cloche		1
2	Poteau central		1

3	Cadre en A poteau de porte		1
4	Enjeu A		12
5	Enjeu B		12
6	Marteau		1
7	Corde de haubanage		12
8	Bonnet de pluie		1

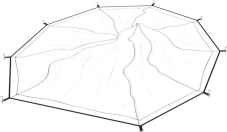
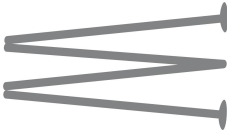
Modèle :ZJTM1303 (Diamètre : 6 m)

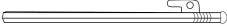

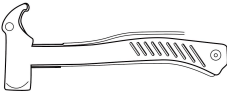
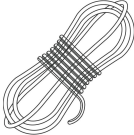
LES PIÈCES LISTE





NON.	NOM	DESSIN	QTÉ
1	Tente cloche		1
2	Poteau central		1

3	Cadre en A poteau de porte		1
4	Enjeu A		14
5	Enjeu B		14
6	Marteau		1
7	Corde de haubanage		14
8	Bonnet de pluie		1

Modèle :ZJTM1304 (Diamètre : 7 m)

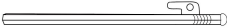
LES PIÈCES LISTE

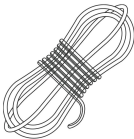
NON.	NOM	DESSIN	QTÉ
1	Tente cloche		1
2	Poteau central		1

3	Cadre en A poteau de porte		1
4	Enjeu A		16
5	Enjeu B		16
6	Marteau		1
7	Corde de haubanage		16
8	Bonnet de pluie		1

INSTRUCTIONS DE MONTAGE

ÉTAPE 1 Réparer le corps de la tente

- Posez votre tente au sol, maintenez le sol tendu avec votre partenaire.

Fixez 10 coins de tente avec le piquet B.

Enjeu B

Marteau

! NOTE:

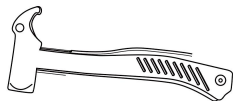
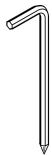

Veillez ne pas trop miser à cette étape pour un ajustement ultérieur.

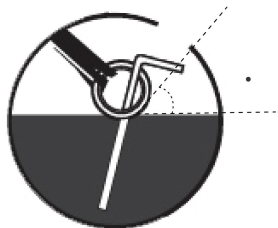
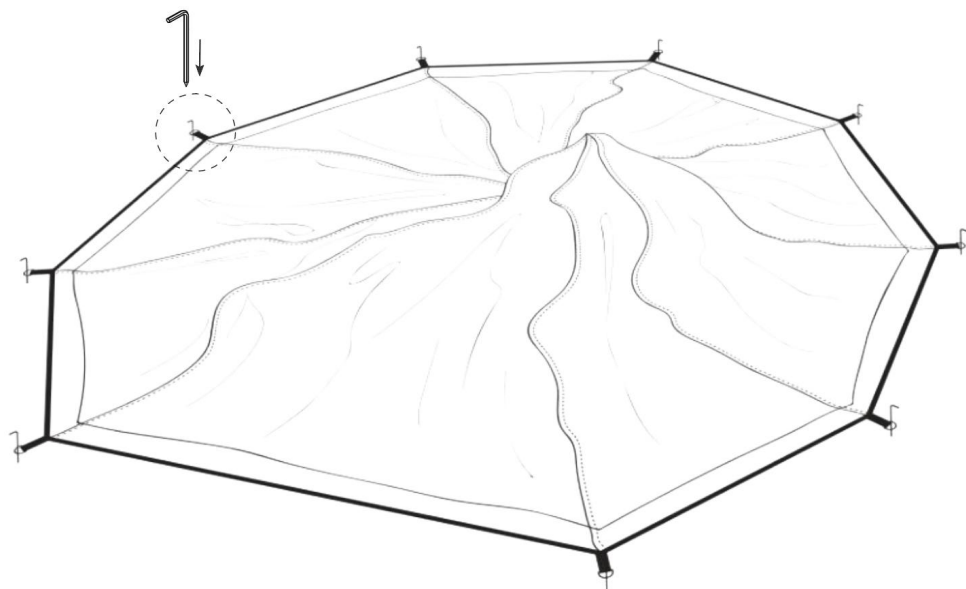

Le piquet maintient un angle de 45° - 60° avec le sol, donc l'angle d'appui la capacité est la plus grande.

ÉTAPE 2

Soutenir la tente

- Assemblez le poteau central à travers la boucle métallique intégrée.

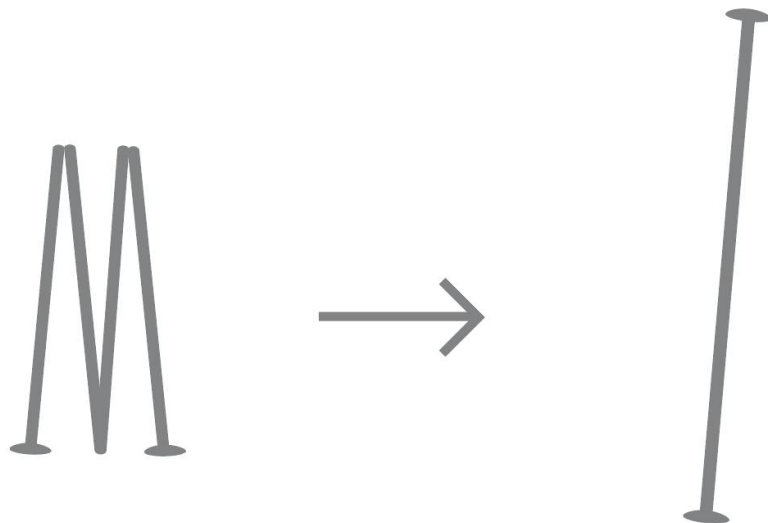

- Une personne a placé le poteau central au milieu du sol pour soutenir la tente.

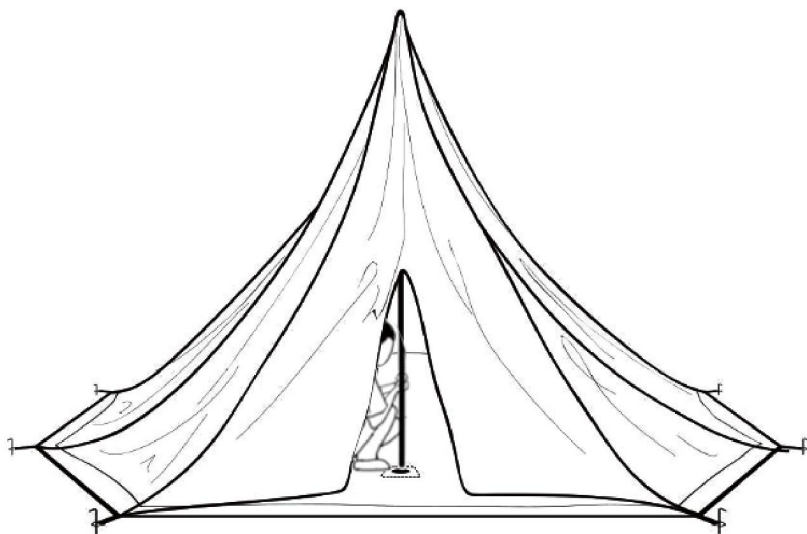

ÉTAPE 3 | Installer le poteau de porte

- Le partenaire a placé le poteau de porte en A à travers l'anneau du haut de

la porte,
puis insérez les pieds du poteau de porte dans les poches situées sous la
porte.

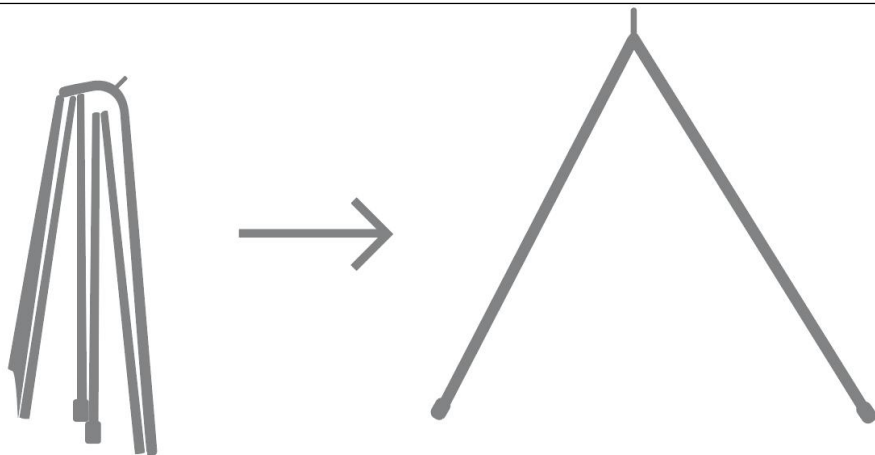

- Fixez le capuchon anti-pluie sur le dessus du poteau de porte à cadre en A.
(Ajustez la mise B après cette étape, si nécessaire.)

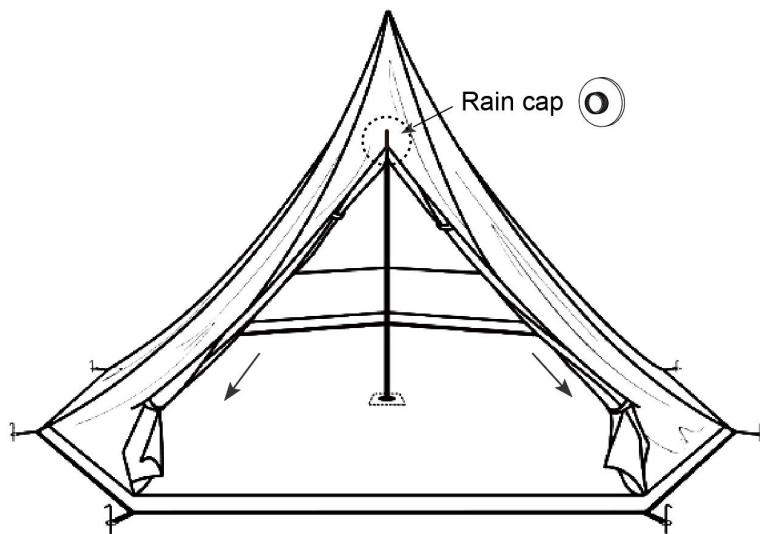

ÉTAPE 4 Terminer l'assemblage de la tente

- Fixez 12 haubans avec le piquet A autour de la tente et redressez-les.

Il est recommandé de retirer les haubans dans le sens de chaque couture. sur le toit de la tente pour obtenir un effet visuel et une stabilité parfaits.
(Ajustez les piquets de la tente après cette étape, si nécessaire.)

Enjeu A

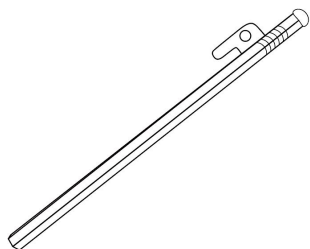

Marteau

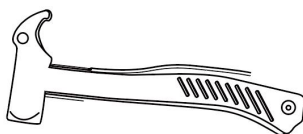

Corde de haubanage

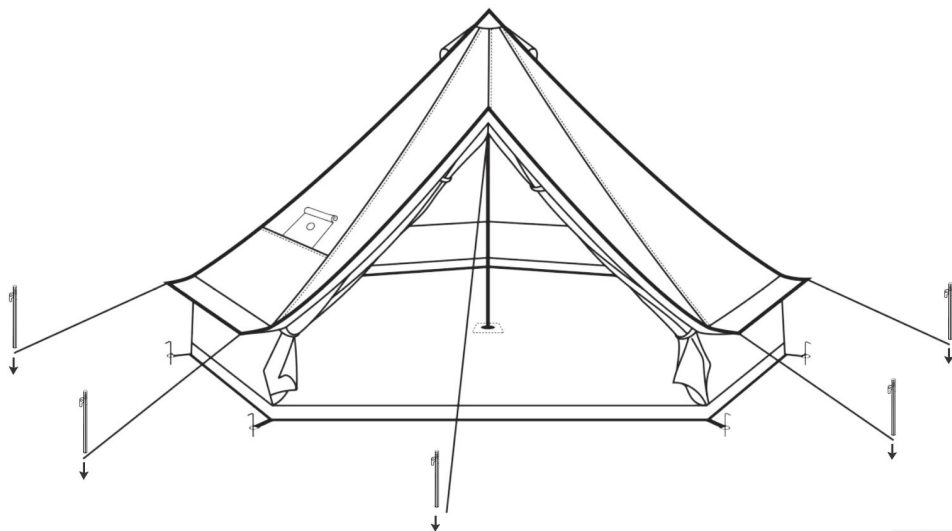
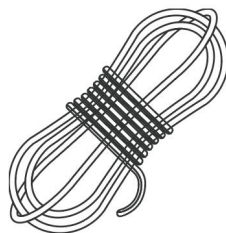

REMARQUE : utilisez la corde la plus longue (la boucle de corde de couleur différente) pour sécuriser la porte de la tente.

Adresse : Baoshanqu Shuangchenglu 803long 11hao 1602A-1609shi Shanghai

Importé en Australie : SIHAO PTY LTD . 1 ROKEVA STREETASTWOOD NSW 2122
Australie

Importé aux États-Unis : Sanven Technology Ltd.Suite 250, 9166 Anaheim Place, Rancho
Cucamonga, CA 91730



SHUNSHUN GmbH
Römeräcker 9 Z2021,76351
Linkenheim-Hochstetten,Germany



Pooledas Group Ltd
Unit 5 Albert Edward House, The Pavilions
Preston, United Kingdom

Fabriqué en Chine

VEVOR[®]

TOUGH TOOLS, HALF PRICE

Technique Assistance et certificat de garantie électronique

www.vevor.com/support

VEVOR[®]

TOUGH TOOLS, HALF PRICE

Technisch Support- und E-Garantie-Zertifikat www.vevor.com/support

JURTENZELT BENUTZERHANDBUCH

We continue to be committed to provide you tools with competitive price.

"Save Half", "Half Price" or any other similar expressions used by us only represents an estimate of savings you might benefit from buying certain tools with us compared to the major top brands and does not necessarily mean to cover all categories of tools offered by us. You are kindly reminded to verify carefully when you are placing an order with us if you are actually saving half in comparison with the top major brands.

VEVOR®

TOUGH TOOLS, HALF PRICE

YURT TENT

Modell: ZJTM1009, ZJTM1149, ZJTM1215, ZJTM1303, ZJTM1304

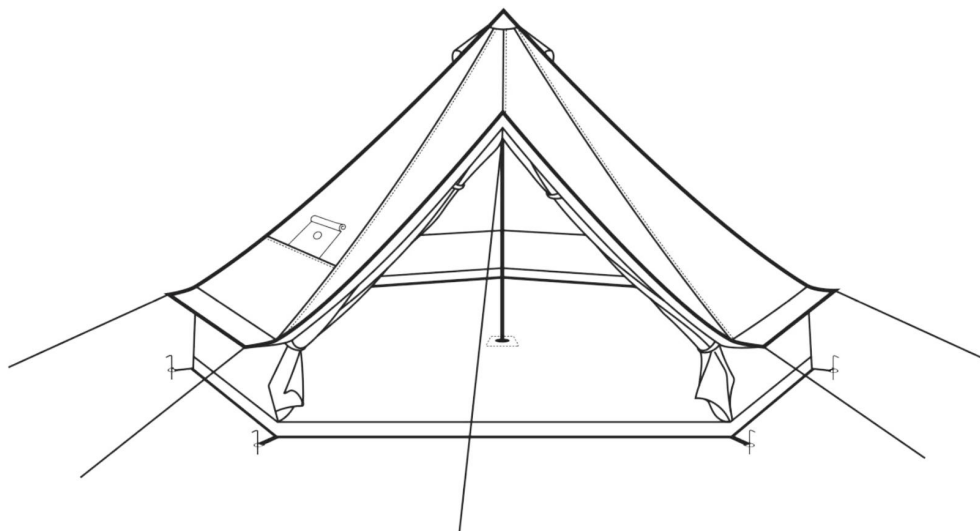

NEED HELP? CONTACT US!

Have product questions? Need technical support? Please feel free to contact us:

Technical Support and E-Warranty Certificate
www.vevor.com/support

This is the original instruction, please read all manual instructions carefully before operating. VEVOR reserves a clear interpretation of our user manual. The appearance of the product shall be subject to the product you received. Please forgive us that we won't inform you again if there are any technology or software updates on our product.

SPEZIFIKATIONEN

Modell	ZJTM1009	
Produktgröße	Durchmesser : 3 m Höhe : 2m Türhöhe : 1,5 m Zaunhöhe : 0,6 m	
Farbe	Beige	

Modell	ZJTM1149	
Produktgröße	Durchmesser : 4 m Höhe : 2,5 m Türhöhe : 1,5 m Zaunhöhe : 0,6 m	
Farbe	Beige	

Modell	ZJTM1215	
Produktgröße	Durchmesser : 5 m Höhe : 3m Höhe der Tür : 1,7 m Zaunhöhe : 0,6 m	
Farbe	Beige	

Modell	ZJTM1303	
Produktgröße	Durchmesser : 6 m Höhe : 3,5 m Höhe der Tür : 1,7 m Zaunhöhe : 0,6 m	
Farbe	Beige	

Modell	ZJTM1304	
Produktgröße	Durchmesser : 7 m Höhe : 3,5 m Höhe der Tür : 1,9 m Zaunhöhe : 0,7 m	
Farbe	Beige	

! VORSICHTSHINWEISE

11. Bitte sehen Sie sich die Teilliste an, um die Artikel, die Sie erhalten haben, sorgfältig zu überprüfen. Werfen Sie keine Verpackung weg, bis Sie überprüft haben, dass Sie alle Teile und Hardware haben! Zögern Sie nicht, uns zu kontaktieren, wenn Sie benötigte Teile vermissen, defekte Teile haben oder andere Installationsprobleme haben.

12. Wählen Sie für die Aufstellung Ihres Zelt es einen ebenen Standort frei von Steinen, Ästen und anderen harten oder scharfen Gegenständen und stellen Sie sicher, dass keine unterirdischen Versorgungsleitungen vorhanden sind. Bauen Sie Ihr Zelt nicht unter Bäumen oder hohen Gebäuden auf, um mögliche Sicherheitsrisiken durch herabfallende Gegenstände zu vermeiden.

13. Das Zelt wurde für den Einsatz als temporäre Struktur hergestellt und entspricht nicht den Bauvorschriften. Der Installateur ist dafür verantwortlich, die Witterungsbedingungen zum richtigen Zeitpunkt der Installation vorherzusehen.

14. Da das Zelt während des Bauprozesses jederzeit repariert werden muss, melden Sie sich bei an mindestens eine Person, die Ihnen beim Aufbau des Zelt es behilflich ist.

15. Die in dieser Bedienungsanleitung beschriebenen Warnungen, Vorsichtsmaßnahmen und Anweisungen können nicht alle möglichen Bedingungen abdecken. Wir haften nicht für Schäden, die durch menschliche Faktoren verursacht werden. Wenn bei der Verwendung des Produkts Probleme auftreten, setzen Sie sich bitte rechtzeitig mit uns in Verbindung.

! WARNUNG

5. Von Kindern, älteren Menschen und anderen Personen fernhalten, um Verletzungen durch herabfallende Metallrahmen während der Installation zu vermeiden.

6. Halten Sie alle Flammen- und Wärmequellen von diesem Zeltstoff fern, um zu verhindern, dass das Zelt durch versehentlichen Kontakt verbrennt.

! PFLEGEANLEITUNG

5. Reinigen Sie Schmutz und halten Sie die Plane trocken, wenn Sie das Zelt lagern. Bewahren Sie den Metallrahmen und die Plane getrennt in der Tragetasche auf, um Schimmel oder Beschädigungen zu vermeiden.

6. ist, verwenden Sie zum Reinigen normales Reinigungsmittel und Wasser.

! VORSICHTSMASSNAHMEN

Wenn Sie ins Freie gehen, sollten Sie folgende Vorsichtsmaßnahmen treffen:

17. Stellen Sie sicher, dass Ihr Zelt ausreichend belüftet ist (insbesondere, wenn Sie die erste Warnung ignorieren und eine Heizung in Ihrem Zelt verwenden). Kohlenmonoxid ist real und kann schwere Schäden wie den Tod verursachen. In den Zeltkörper sind Lüftungsschlitze und Fliegengitter eingebaut.

18. Achten Sie darauf, Ihr Zelt richtig zu verankern – es handelt sich nicht um ein freistehendes Zelt – befolgen Sie diese Anweisungen für die richtige Absteckung und stellen Sie sicher, dass alle Abspannleinen und Heringe sicher befestigt sind.

19. Stellen Sie sicher, dass Kinder im und um das Zelt jederzeit beaufsichtigt werden.

20. Benutzen Sie keine Kerzen, Streichhölzer oder offene Flammen jeglicher Art in oder in der Nähe eines Zeltes.

21. Es ist besser, nicht in einem Zelt zu kochen, aber wenn ja, lassen Sie das Kochen nicht unbeaufsichtigt. Stellen Sie sicher, dass Grills, Kochgeräte und Ähnliches nicht näher als 1 Meter an der Zeltplane angebracht werden dürfen. In Zelten oder in der Nähe von Zeltplanen sollte kein offenes Feuer oder glühende Holzkohle verwendet werden – Feuer kann sich sehr schnell ausbreiten. In Zelten oder in der Nähe von Zeltplanen sollte kein offenes Feuer oder glühende Holzkohle verwendet werden, da ein erhebliches Risiko durch die Bildung von Kohlenmonoxid (CO) besteht, insbesondere in engen Räumen im Zelt. Alle

flexiblen Schläuche und Kupplungen zum Gasbrenner sollten auf Dichtheit und einwandfreien Zustand überprüft werden.



22. Machen Sie Lagerfeuer windabwärts und mehrere Meter von einem Zelt entfernt und löschen Sie die Lagerfeuer unbedingt vollständig, bevor Sie einen Campingplatz verlassen oder sich für die Nacht zurückziehen.

23. Seien Sie äußerst vorsichtig, wenn Sie brennstoffbetriebene Laternen oder Heizgeräte in einem Zelt verwenden, und verwenden Sie nach Möglichkeit batteriebetriebene Laternen. Betanken Sie keine Lampen, Heizgeräte oder Öfen im Zelt. Löschen Sie alle Laternen oder schalten Sie sie aus, bevor Sie schlafen gehen.

24. Rauchen Sie nicht in einem Zelt und lagern Sie keine brennbaren Flüssigkeiten in einem Zelt. Die Installation von Holzbrennern oder Heizgeräten erfolgt auf eigene Gefahr.

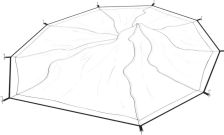
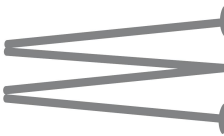
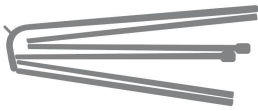
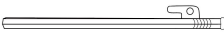

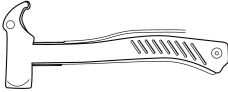
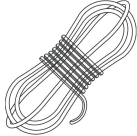
ANLEITUNG AUFBEWAHREN



Modell : ZJTM1009 (Durchmesser : 3 m)			
TEILE AUFFÜHREN			
NEIN.	NAME	ZEICHNUNG	MENGE
1	Rundzelt		1
2	Mittelstange		1
3	A - Rahmen Türpfosten		1
4	Pfahl A		10

5	Pfahl B		10
6	Hammer		1
7	Abspannseil		10
8	Regenkappe		1

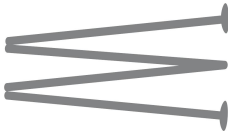
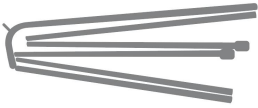
Modell : ZJTM1149 (Durchmesser : 4 m)

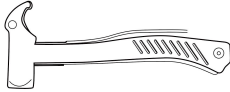
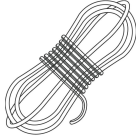

TEILE AUFFÜHREN



NEIN.	NAME	ZEICHNUNG	MENGE
1	Rundzelt		1
2	Mittelstange		1
3	A - Rahmen Türpfosten		1
4	Pfahl A		12

5	Pfahl B		12
6	Hammer		1
7	Abspannseil		12
8	Regenkappe		1

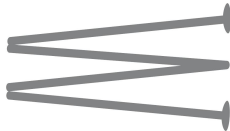
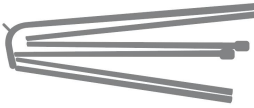
Modell : ZJTM1215 (Durchmesser : 5 m)

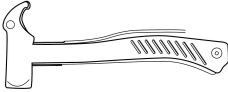
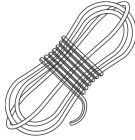

TEILE AUFFÜHREN



NEIN.	NAME	ZEICHNUNG	MENGE
1	Rundzelt		1
2	Mittelstange		1
3	A - Rahmen Türpfosten		1
4	Pfahl A		12

5	Pfahl B		12
6	Hammer		1
7	Abspannseil		12
8	Regenkappe		1

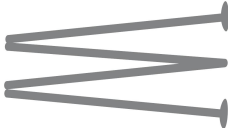
Modell : ZJTM1303 (Durchmesser : 6 m)



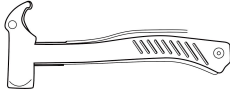
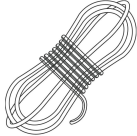

TEILE AUFFÜHREN

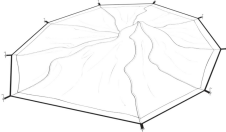

NEIN.	NAME	ZEICHNUNG	MENGE
1	Rundzelt		1
2	Mittelstange		1
3	A - Rahmen Türpfosten		1
4	Pfahl A		14

5	Pfahl B		14
6	Hammer		1
7	Abspannseil		14
8	Regenkappe		1

Modell : ZJTM1304 (Durchmesser : 7 m)

TEILE AUFFÜHREN

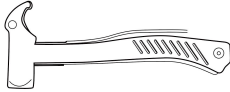
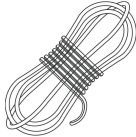
NEIN.	NAME	ZEICHNUNG	MENGE
1	Rundzelt		1
2	Mittelstange		1
3	A - Rahmen Türpfosten		1
4	Pfahl A		16

5	Pfahl B		16
6	Hammer		1
7	Abspannseil		16
8	Regenkappe		1

BAUANLEITUNG

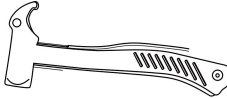
SCHRITT		Befestigen Sie den Zeltkörper
1		
<ul style="list-style-type: none"> • Legen Sie Ihr Zelt auf den Boden und halten Sie den Boden mit Ihrem Partner fest. Stecken Sie 10 Zeltecken mit dem Pflock B ab. 		
Pfahl B	Hammer	! NOTIZ: Bitte stecken Sie bei diesem Schritt nicht zu viel ab, um später Anpassungen vornehmen zu können.
		

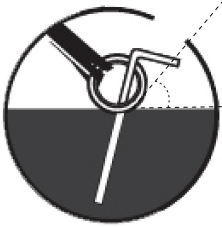
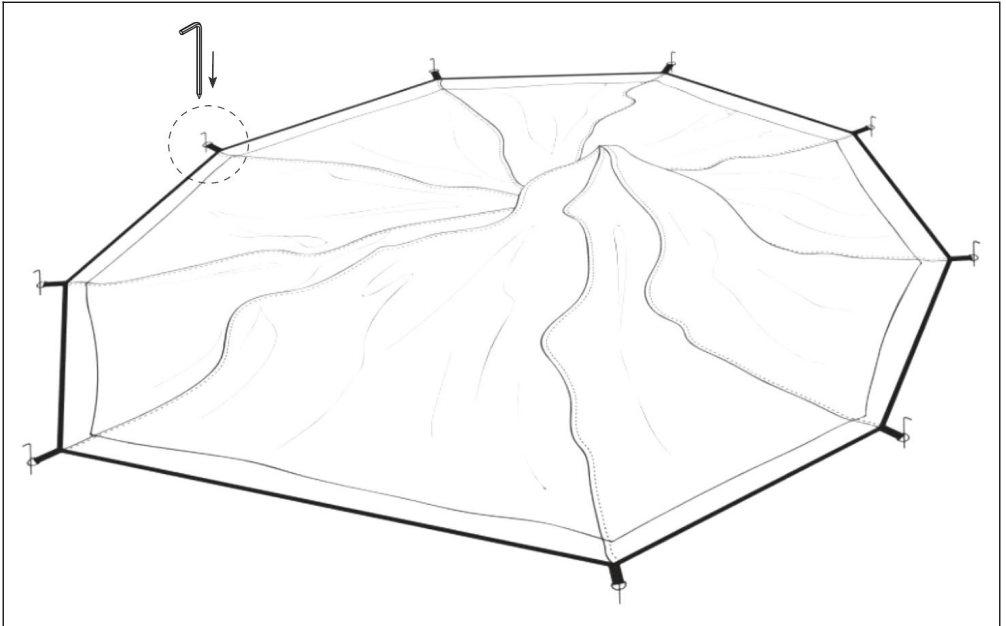

Der Pfahl bildet einen Winkel von 45° - 60° zum Boden, also den Peilwinkel
Die Kapazität ist am größten.

SCHRITT

Stützen Sie das Zelt ab

2

- Befestigen Sie die Mittelstange mithilfe der integrierten Metallschnalle.

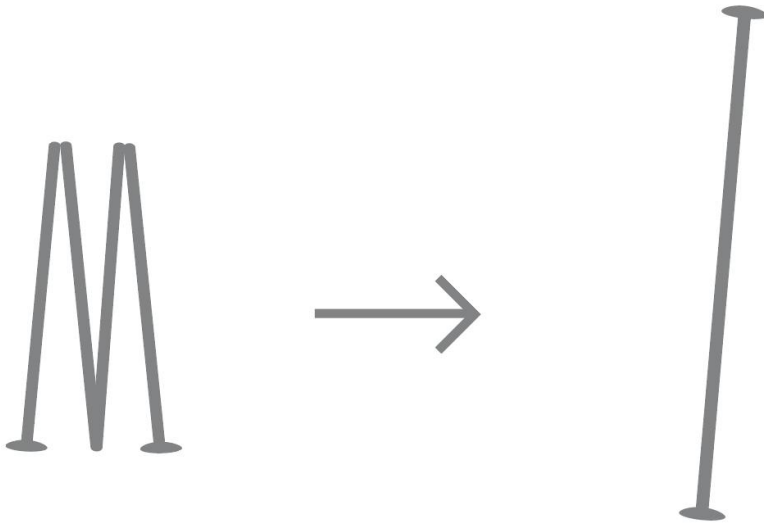

- Eine Person stellt die Mittelstange auf die Mitte des Bodens, um das Zelt abzustützen.

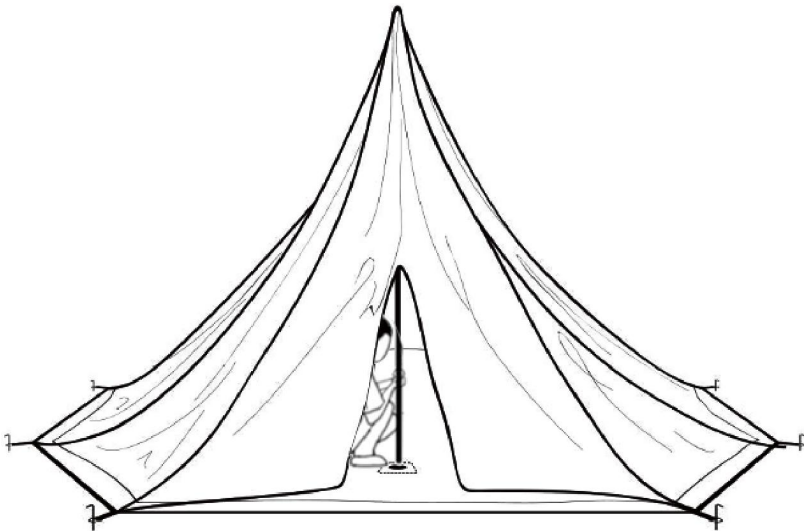

SCHRITT Türstange montieren

3

- Der Partner führt die A-Rahmen-Türstange durch den Ring der Türoberseite.

Stecken Sie dann die Füße der Türstange in die Taschen an der Unterseite der Tür.

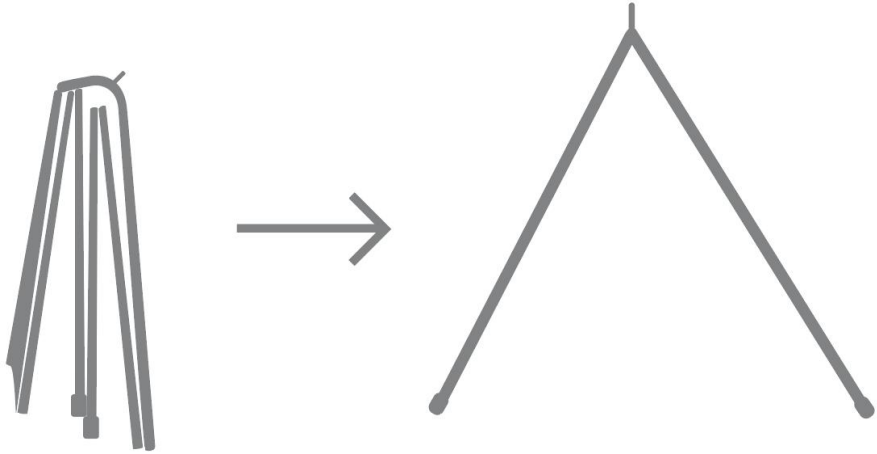

- Bringen Sie die Regenkappe oben an der A-Rahmen-Türstange an.

(Nehmen Sie nach diesem Schritt ggf. Anpassungen am Einsatz B vor.)

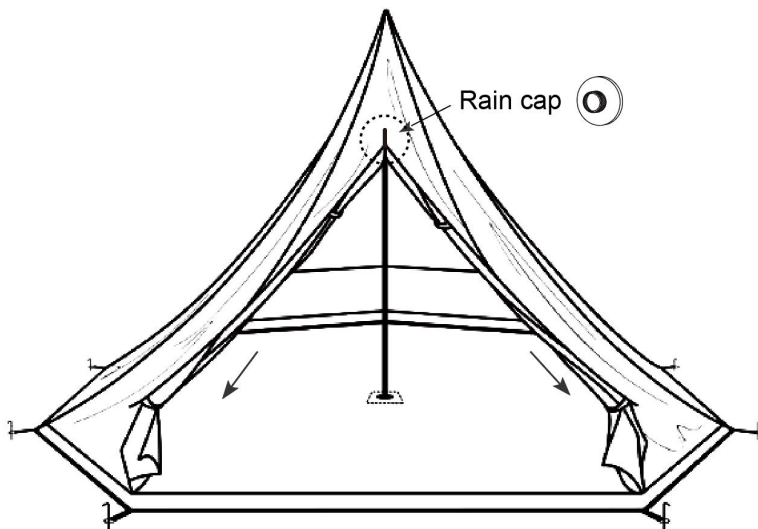

SCHRITT**Beenden Sie den Zeltaufbau**

4

- Befestigen Sie 12 Abspannseile mit Erdspieß A rund um das Zelt und richten Sie diese aus.

Wir empfehlen, Abspannseile entlang der Nahrichtung herauszuziehen auf dem Zeltdach, um die perfekte optische Wirkung und Stabilität zu erzielen. (Nehmen Sie nach diesem Schritt ggf. Anpassungen an den Zeltpfählen vor.)

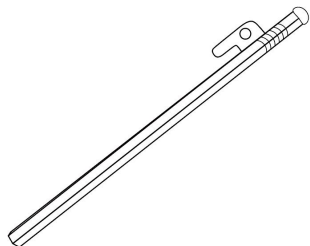
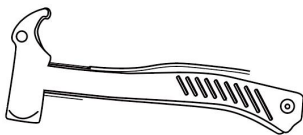
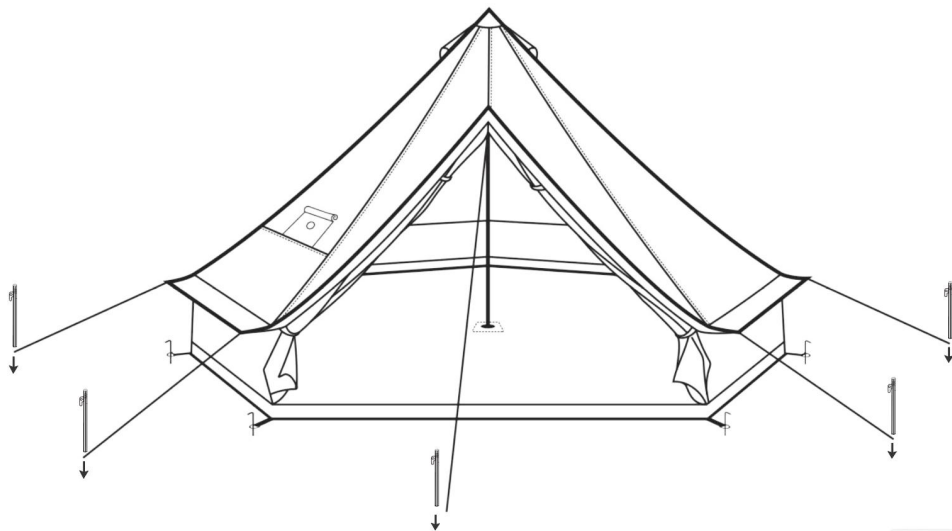
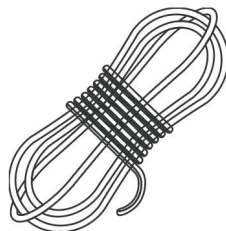
Pfahl A**Hammer****Abspannseil**

HINWEIS: Verwenden Sie das längste Seil (die Seilschnalle in einer anderen Farbe), um die Zelttür zu sichern.

Adresse: Baoshanqu Shuangchenglu 803long 11hao 1602A-1609shi Shanghai

Importiert nach AUS: SIHAO PTY LTD . 1 ROKEVA STREETEASTWOOD NSW 2122
Australien

In die USA importiert: Sanven Technology Ltd. Suite 250, 9166 Anaheim Place, Rancho
Cucamonga, CA 91730



SHUNSHUN GmbH
Römeräcker 9 Z2021,76351
Linkenheim-Hochstetten, Germany



Pooledas Group Ltd
Unit 5 Albert Edward House, The Pavilions
Preston, United Kingdom

In China hergestellt

VEVOR[®]

TOUGH TOOLS, HALF PRICE

Technisch Support- und E-Garantiezertifikat

www.vevor.com/support

VEVOR[®]

TOUGH TOOLS, HALF PRICE

Tecnico Supporto e certificato di garanzia elettronica www.vevor.com/support

TENDA YURTA MANUALE D'USO

We continue to be committed to provide you tools with competitive price.

"Save Half", "Half Price" or any other similar expressions used by us only represents an estimate of savings you might benefit from buying certain tools with us compared to the major top brands and does not necessarily mean to cover all categories of tools offered by us. You are kindly reminded to verify carefully when you are placing an order with us if you are actually saving half in comparison with the top major brands.

VEVOR®

TOUGH TOOLS, HALF PRICE

YURT TENT

Modello: ZJTM1009, ZJTM1149, ZJTM1215, ZJTM1303, ZJTM1304

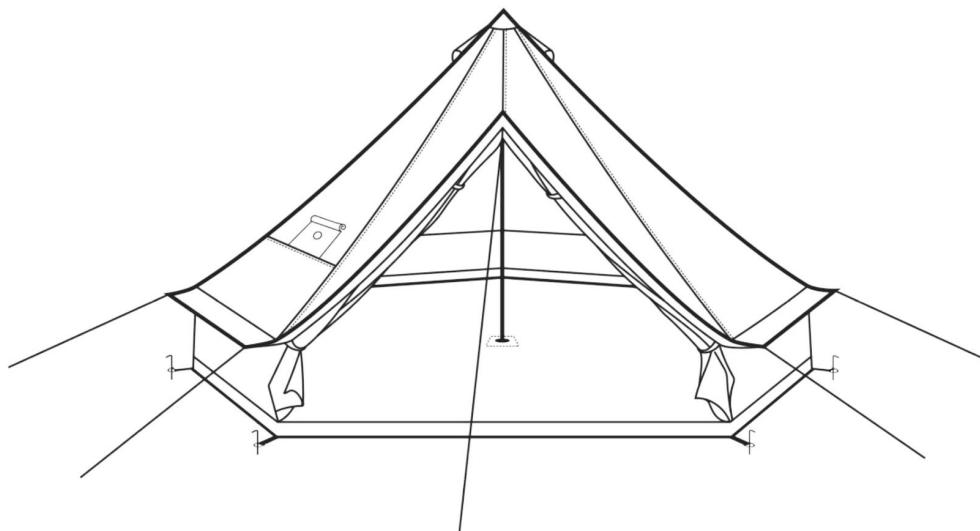

NEED HELP? CONTACT US!

Have product questions? Need technical support? Please feel free to contact us:

Technical Support and E-Warranty Certificate
www.vevor.com/support

This is the original instruction, please read all manual instructions carefully before operating. VEVOR reserves a clear interpretation of our user manual. The appearance of the product shall be subject to the product you received. Please forgive us that we won't inform you again if there are any technology or software updates on our product.

SPECIFICHE

Modello	ZJTM1009	
Taglia del prodotto	Diametro : 3 m Altezza : 2 m Altezza della porta : 1,5 m Altezza della recinzione : 0,6 m	
Colore	Beige	

Modello	ZJTM1149	
Taglia del prodotto	Diametro : 4 m Altezza : 2,5 m Altezza della porta : 1,5 m Altezza della recinzione : 0,6 m	
Colore	Beige	

Modello	ZJTM1215	
Taglia del prodotto	Diametro : 5 m Altezza : 3 m Altezza della porta : 1,7 m Altezza della recinzione : 0,6 m	
Colore	Beige	

Modello	ZJTM1303	
Taglia del prodotto	Diametro : 6 m Altezza : 3,5 m Altezza della porta : 1,7 m Altezza della recinzione : 0,6 m	
Colore	Beige	

Modello	ZJTM1304	
Taglia del prodotto	Diametro : 7 m Altezza : 3,5 m Altezza della porta : 1,9 m Altezza della recinzione : 0,7 m	
Colore	Beige	

! ATTENZIONE

16. Si prega di fare riferimento all'elenco delle parti per controllare attentamente gli articoli ricevuti, non gettare l'imballaggio finché non si è verificato di avere tutte le parti e l'hardware! Non esitare a contattarci se hai perso parti, hai parti rotte o hai altri problemi di installazione.

17. Seleziona un sito pianeggiante privo di rocce, rami e altri oggetti duri o appuntiti per installare la tenda e assicurati che non siano presenti servizi sotterranei. Non montare la tenda sotto alberi o edifici alti per evitare potenziali rischi per la sicurezza causati dalla caduta di oggetti.

18. La tenda è prodotta per essere utilizzata come struttura temporanea e non soddisfa il codice strutturale, l'installatore è responsabile di prevedere la gravità delle condizioni atmosferiche per il momento corretto dell'installazione.

19. Poiché la tenda deve essere riparata in qualsiasi momento durante il processo di costruzione, iscriviti a almeno una persona che ti assista quando è il momento di montare la tenda.

20. Le avvertenze, le precauzioni e le istruzioni descritte nel presente manuale di istruzioni non possono coprire tutte le condizioni possibili. Non saremo responsabili per eventuali danni causati da fattori umani. In caso di problemi durante l'utilizzo del prodotto, contattaci in tempo.

! AVVERTIMENTO

7. Tenere lontano dalla portata dei bambini, degli anziani e di altre persone per evitare lesioni personali causate dalla caduta dei telai metallici durante l'installazione.

8. Tenere tutte le fiamme e le fonti di calore lontane dal tessuto della tenda per evitare che la tenda bruci per contatto accidentale.

! ISTRUZIONI PER LA CURA

7. Pulisci i detriti e mantieni la tela asciutta quando riponi la tenda, riponi il telaio metallico e la tela separatamente nella borsa per il trasporto per evitare muffe o danni.

8. Utilizzare detersivo normale e acqua per pulire se la tenda è sporca.

! PRECAUZIONI

Quando si esce all'aperto è necessario adottare le seguenti precauzioni:

25. Assicurati che la tua tenda sia adeguatamente ventilata (soprattutto se decidi di ignorare il primo avvertimento e utilizzare un riscaldatore nella tenda). Il monossido di carbonio è reale e può causare danni gravi, fino alla morte. Prese d'aria e schermi sono integrati nel corpo della tenda.

26. Assicurati di ancorare correttamente la tenda (non si tratta di una tenda indipendente), segui queste istruzioni per pratiche di picchettamento corrette e assicurati che tutti i tiranti e i picchetti siano fissati saldamente.

27. Assicurarsi che i bambini siano sempre sorvegliati dentro e intorno alla tenda.

28. Non utilizzare candele, fiammiferi o fiamme libere di alcun tipo all'interno o in prossimità della tenda.

29. È meglio non cucinare all'interno di una tenda, ma se lo fai, non lasciare la cucina incustodita. Assicurarsi che griglie, apparecchi di cottura e simili non siano posizionati a meno di 1 metro dal telo della tenda. Non si dovrebbero usare fuochi aperti o carbone ardente all'interno delle tende o vicino al telo della tenda: il fuoco può diffondersi molto rapidamente. Non si dovrebbero utilizzare fuochi aperti o carbone ardente all'interno delle



tende o vicino al telo della tenda poiché esiste un rischio significativo di accumulo di monossido di carbonio (CO), in particolare in uno spazio ristretto all'interno della tenda. Tutti i tubi flessibili e i raccordi del bruciatore a gas devono essere controllati per eventuali perdite e che siano in buone condizioni.



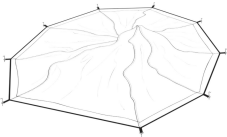

30. Costruisci fuochi da campo sottovento e a diversi metri di distanza da una tenda e assicurati di spegnere completamente i fuochi da campo prima di lasciare il campeggio o prima di ritirarti per la notte.

31. Prestare estrema attenzione quando si utilizzano lanterne o stufe alimentate a carburante all'interno di una tenda e utilizzare lanterne a batteria quando possibile. Non rifornire di carburante lampade, riscaldatori o fornelli all'interno di una tenda. Spegni o spegni tutte le lanterne prima di andare a dormire.

32. Non fumare in una tenda né conservare liquidi infiammabili all'interno della tenda. L'installazione di bruciatori a legna o apparecchi di riscaldamento avviene a proprio rischio e pericolo.

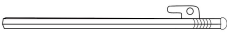
CONSERVA QUESTE ISTRUZIONI

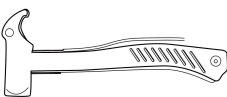
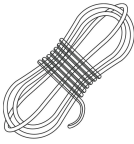



Modello : ZJTM1009 (Diametro : 3 m)			
PARTI ELENCO			
NO.	NOME	DISEGNO	QUANTITÀ
1	Tenda a campana		1
2	Polo centrale		1
3	A- frame e palo della porta		1

4	Palo A		10
5	Palo B		10
6	Martello		1
7	Corda per ragazzi		10
8	Berretto anti-pioggia		1

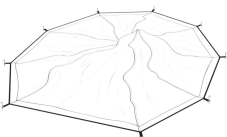
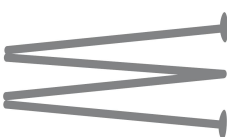
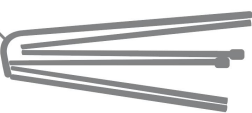
Modello : ZJTM1149 (Diametro : 4 m)

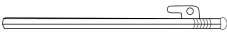

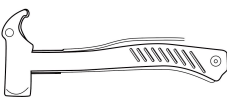
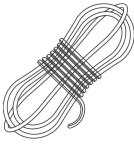
PARTI ELENCO



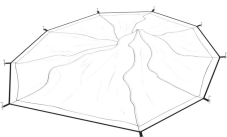
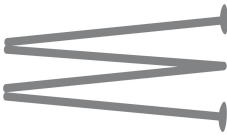

NO.	NOME	DISEGNO	QUANTITÀ
1	Tenda a campana		1
2	Polo centrale		1
3	A- frame e palo della porta		1

4	Palo A		12
5	Palo B		12
6	Martello		1
7	Corda per ragazzi		12
8	Berretto anti-pioggia		1

Modello : ZJTM1215 (Diametro : 5 m)

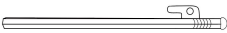

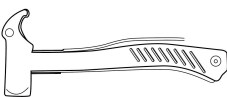
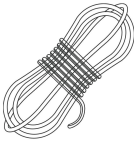
PARTI ELENCO



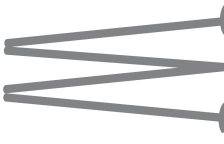

NO.	NOME	DISEGNO	QUANTITÀ
1	Tenda a campana		1
2	Polo centrale		1
3	A- frame e palo della porta		1

4	Palo A		12
5	Palo B		12
6	Martello		1
7	Corda per ragazzi		12
8	Berretto anti-pioggia		1

Modello : ZJTM1303 (Diametro : 6 m)

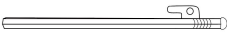

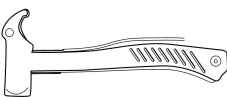
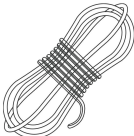
PARTI ELENCO



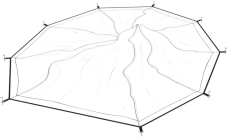
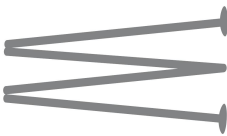

NO.	NOME	DISEGNO	QUANTITÀ
1	Tenda a campana		1
2	Polo centrale		1
3	A- frame e palo della porta		1

4	Palo A		14
5	Palo B		14
6	Martello		1
7	Corda per ragazzi		14
8	Berretto anti-pioggia		1

Modello : ZJTM1304 (Diametro : 7 m)

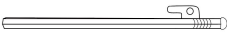
PARTI ELENCO

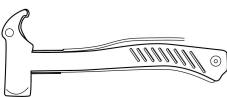
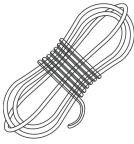
NO.	NOME	DISEGNO	QUANTITÀ
1	Tenda a campana		1
2	Polo centrale		1
3	A- frame e palo della porta		1

4	Palo A		16
5	Palo B		16
6	Martello		1
7	Corda per ragazzi		16
8	Berretto anti-pioggia		1

ISTRUZIONI DI ASSEMBLAGGIO

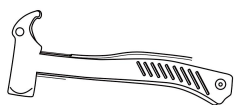
PASSO 1		Fissare il corpo della tenda
<ul style="list-style-type: none"> • Appoggiate la tenda a terra, tenete il pavimento teso con il compagno. <p>Fissate 10 angoli della tenda con il picchetto B.</p>		
Palo B	Martello	<p>! NOTA: Si prega di non puntare troppo in questo passaggio per eventuali aggiustamenti successivi.</p>
		

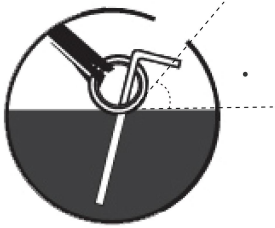
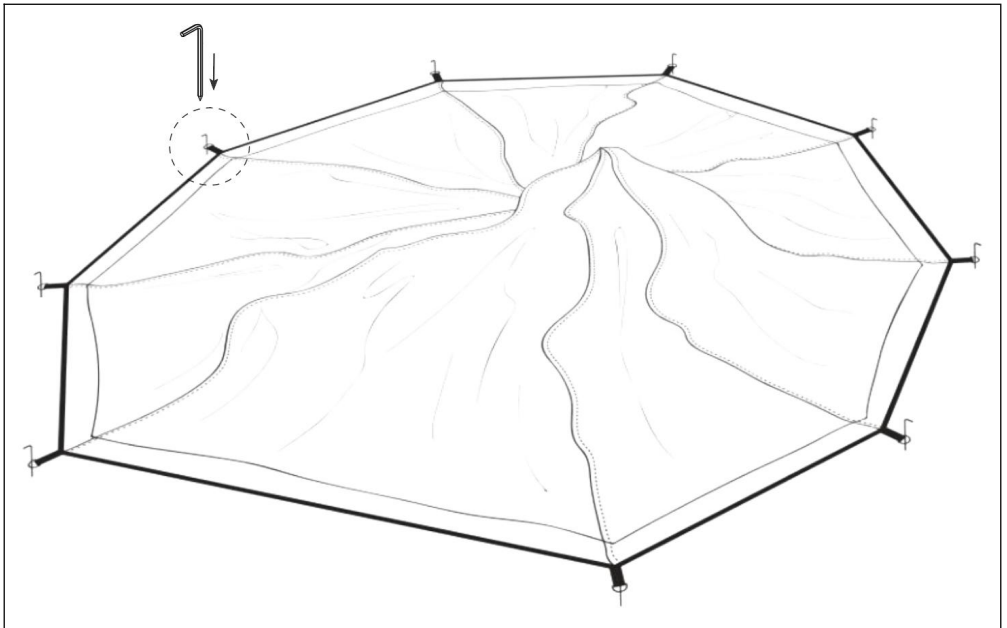

Il picchetto mantiene un angolo di 45° - 60° con il terreno, quindi l'angolo di appoggio la capacità è la più grande.

PASSO 2 Sostieni la tenda

- Montare il palo centrale attraverso la fibbia metallica incorporata.

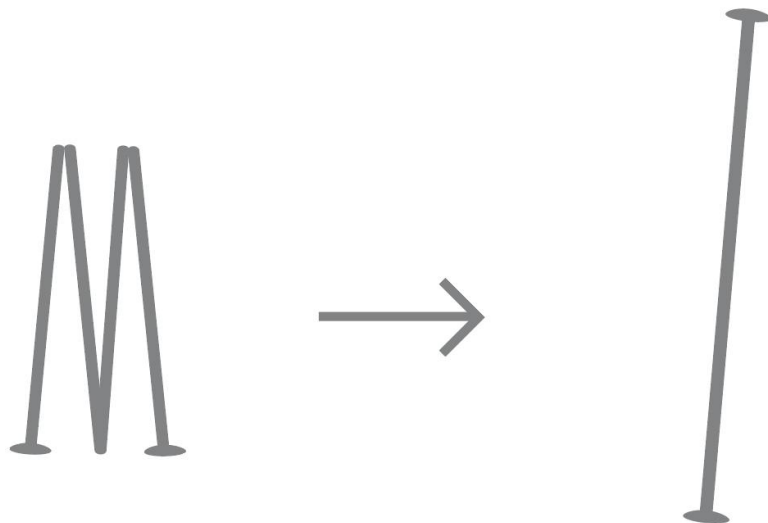

- Una persona posiziona il palo centrale al centro del pavimento per sostenere la tenda.

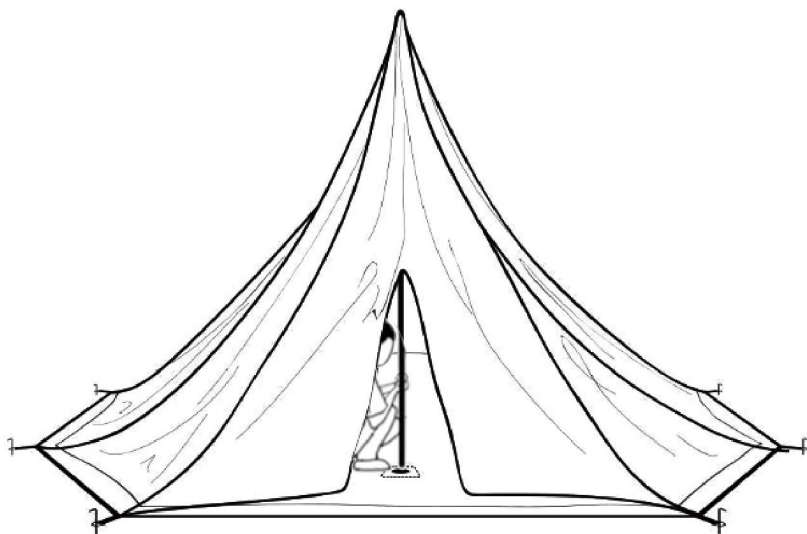

PASSO 3 | Installare il palo della porta

- Il partner inserisce il palo della porta con telaio ad A attraverso l'anello

superiore della porta,
quindi inserire i piedini del palo della porta nelle tasche sul lato inferiore della
porta.

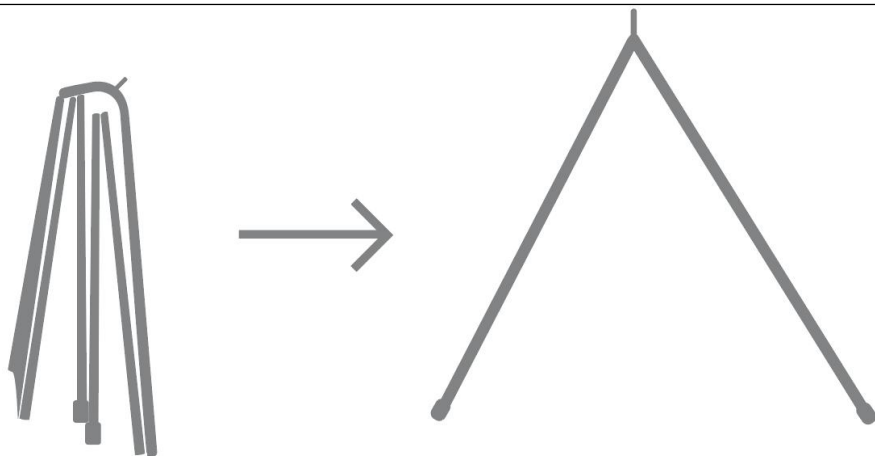

- Attaccare il cappuccio anti-pioggia sulla parte superiore del palo della porta con telaio ad A.
(Se necessario, apporta modifiche alla puntata B dopo questo passaggio.)

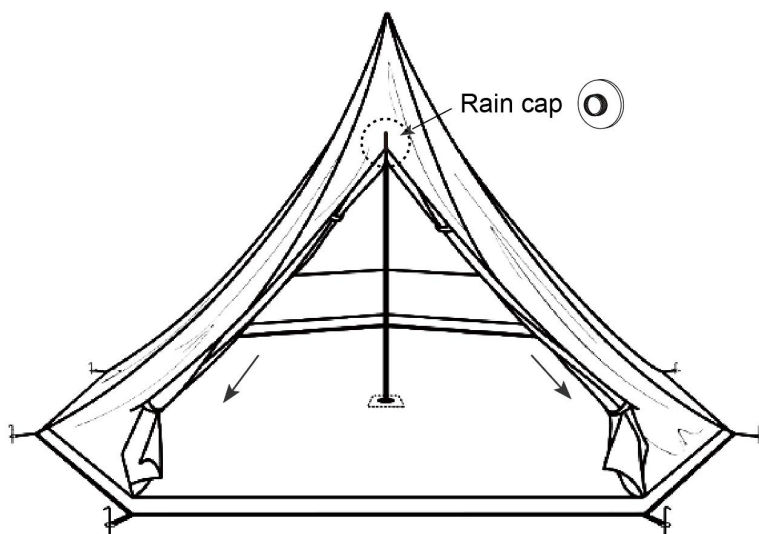

PASSO 4

Termina il montaggio della tenda

- Fissare 12 tiranti con il picchetto A attorno alla tenda e raddrizzarli.

Si consiglia di estrarre i tiranti lungo la direzione di ogni cucitura sul tetto della tenda per ottenere l'effetto visivo e la stabilità perfetti.

(Se necessario, apporta modifiche ai picchetti della tenda dopo questo passaggio.)

Palo A

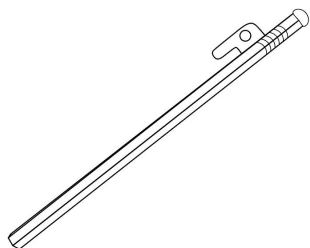

Martello

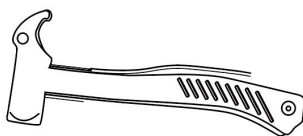

Corda per ragazzi

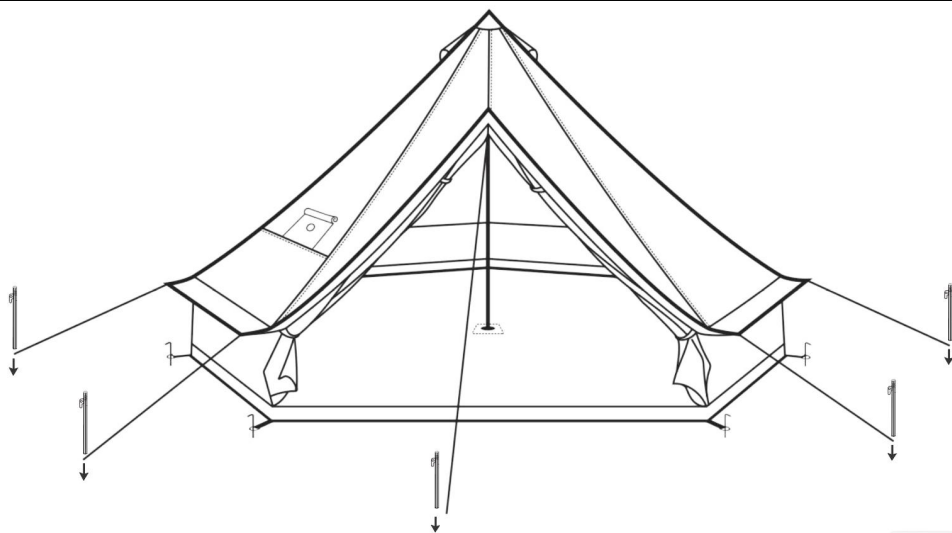
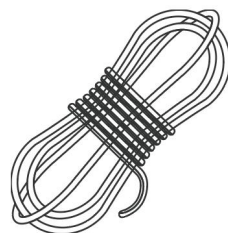

NOTA: utilizzare la corda più lunga (la fibbia della corda di colore diverso) per fissare la porta della tenda.

Indirizzo: Baoshanqu Shuangchenglu 803long 11hao 1602A-1609shi Shanghai

Importato in AUS: SIHAO PTY LTD . 1 ROKEVA STREETEASTWOOD NSW 2122
Australia

Importato negli Stati Uniti: Sanven Technology Ltd.Suite 250, 9166 Anaheim Place,
Rancho Cucamonga, CA 91730



SHUNSHUN GmbH
Römeräcker 9 Z2021,76351
Linkenheim-Hochstetten,Germany



Pooledas Group Ltd
Unit 5 Albert Edward House, The Pavilions
Preston, United Kingdom

Made in China

VEVOR[®]

TOUGH TOOLS, HALF PRICE

Tecnico Supporto e certificato di garanzia elettronica

www.vevor.com/support

VEVOR[®]

TOUGH TOOLS, HALF PRICE

Técnico Soporte y certificado de garantía electrónica www.vevor.com/support

TIENDA YURTA MANUAL DE USUARIO

We continue to be committed to provide you tools with competitive price.

"Save Half", "Half Price" or any other similar expressions used by us only represents an estimate of savings you might benefit from buying certain tools with us compared to the major top brands and does not necessarily mean to cover all categories of tools offered by us. You are kindly reminded to verify carefully when you are placing an order with us if you are actually saving half in comparison with the top major brands.

VEVOR®

TOUGH TOOLS, HALF PRICE

YURT TENT

Modelo: ZJTM1009, ZJTM1149, ZJTM1215, ZJTM1303, ZJTM1304

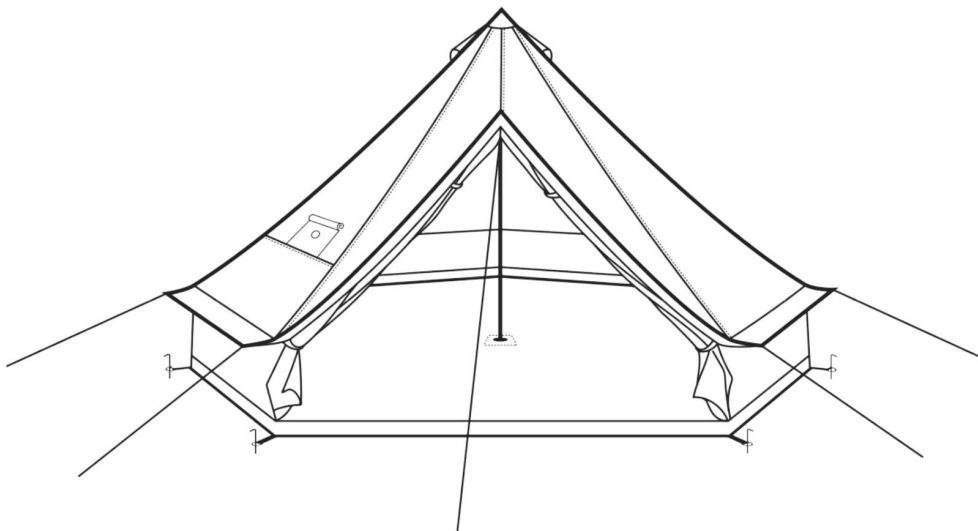

NEED HELP? CONTACT US!

Have product questions? Need technical support? Please feel free to contact us:

Technical Support and E-Warranty Certificate
www.vevor.com/support

This is the original instruction, please read all manual instructions carefully before operating. VEVOR reserves a clear interpretation of our user manual. The appearance of the product shall be subject to the product you received. Please forgive us that we won't inform you again if there are any technology or software updates on our product.

ESPECIFICACIONES

Modelo	ZJTM1009	<p>Diagrama de un toldo con especificaciones de tamaño: diámetro de 3m, altura de 2m, altura de la puerta de 1.5m y altura de la valla de 0.6m.</p>
Tamaño del producto	<p>Diámetro : 3m _</p> <p>Altura : 2m</p> <p>Altura de la puerta : 1,5 m</p> <p>Altura de la valla : 0,6 m</p>	
Color	Beige	

Modelo	ZJTM1149	<p>Diagrama de un toldo con especificaciones de tamaño: diámetro de 4m, altura de 2.5m, altura de la puerta de 1.5m y altura de la valla de 0.6m.</p>
Tamaño del producto	<p>Diámetro : 4m _</p> <p>Altura : 2,5 m</p> <p>Altura de la puerta : 1,5 m</p> <p>Altura de la valla : 0,6 m</p>	
Color	Beige	

Modelo	ZJTM1215	<p>Diagrama de un toldo con especificaciones de tamaño: diámetro de 5m, altura de 3m, altura de la puerta de 1.7m y altura de la valla de 0.6m.</p>
Tamaño del producto	<p>Diámetro : 5m _</p> <p>Altura : 3m</p> <p>Altura de la puerta : 1,7 m</p> <p>Altura de la valla : 0,6 m</p>	
Color	Beige	

Modelo	ZJTM1303	
Tamaño del producto	Diámetro : 6m _ Altura : 3,5 m Altura de la puerta : 1,7 m Altura de la valla : 0,6 m	
Color	Beige	

Modelo	ZJTM1304	
Tamaño del producto	Diámetro : 7m _ Altura : 3,5 m Altura de la puerta : 1,9 m Altura de la valla : 0,7 m	
Color	Beige	

! PRECAUCIONES

21. Consulte la lista de piezas para verificar cuidadosamente los artículos que recibió. ¡No deseche ningún paquete hasta que haya verificado que tiene todas las piezas y el hardware! No dude en contactarnos si le faltan piezas , tiene piezas rotas o tiene algún otro problema de instalación.

22. Seleccione un sitio nivelado, libre de rocas, ramas y otros objetos duros o afilados para instalar su tienda y asegúrese de que no haya servicios subterráneos. No instale su tienda de campaña debajo de árboles o edificios altos para evitar posibles riesgos de seguridad causados por la caída de objetos.

23. La carpa está fabricada para usarse como estructura temporal y no cumple con el código estructural; el instalador es responsable de anticipar la severidad del clima para el momento adecuado de instalación.

24. Como la tienda necesita ser reparada en cualquier momento durante el proceso de construcción, regístrese en Al menos una persona que le ayude cuando llegue el momento de montar la tienda.

25. Las advertencias, precauciones e instrucciones analizadas en este manual de instrucciones no pueden cubrir todas las condiciones posibles. No seremos responsables de ningún daño causado por factores humanos. Si hay algún problema durante el uso del producto, contáctenos a tiempo.

! ADVERTENCIA

9. Manténgalo alejado de niños, ancianos y otras personas para evitar lesiones personales causadas por la caída de marcos metálicos durante la instalación.

10. Mantenga todas las llamas y fuentes de calor alejadas de la tela de esta tienda para evitar que la tienda se queme por contacto accidental.

! INSTRUCCIÓN DE CUIDADO

9. Limpie los escombros y mantenga la lona seca cuando guarde la tienda, guarde el marco de metal y la lona por separado en la bolsa de transporte para evitar moho o daños.

10. Utilice detergente normal y agua para limpiar si la tienda está sucia.

! PRECAUCIONES

Se deben tomar las siguientes precauciones al salir al aire libre:

33. Asegúrese de que su tienda esté adecuadamente ventilada (especialmente si decide ignorar la primera advertencia y usar un calentador en su tienda). El monóxido de carbono es real y puede causar daños graves, como la muerte. Las rejillas de ventilación y las pantallas están integradas en el cuerpo de la tienda.

34. Asegúrese de anclar su tienda de campaña correctamente (esta no es una tienda de campaña independiente); siga estas instrucciones para conocer las prácticas de replanteo adecuadas y asegúrese de que todos los vientos y clavijas estén bien fijados.

35. Asegúrese de que los niños estén supervisados dentro y alrededor de la tienda en todo momento.

36. No utilice velas, fósforos ni llamas abiertas de ningún tipo dentro o cerca de una tienda de campaña.

37. Es mejor no cocinar dentro de una tienda de campaña, pero si lo hace, no deje la comida desatendida. Asegúrese de que las parrillas, aparatos de cocina y similares no se coloquen a menos de 1 metro de la lona de la tienda. No se deben utilizar fogatas ni carbón incandescente dentro de las tiendas o cerca de las lonas de las mismas; el fuego puede propagarse muy rápidamente. No se deben utilizar fogatas ni carbón incandescente dentro de las tiendas de campaña o cerca de las lonas de las mismas, ya que existe un riesgo significativo de acumulación de monóxido de carbono (CO), particularmente en un espacio



confinado dentro de la tienda. Se deben revisar todos los tubos flexibles y acoplamientos del quemador de gas para detectar fugas y que estén en buen estado.



38. Encienda fogatas a favor del viento y a varios metros de distancia de una tienda de campaña y asegúrese de apagarlas por completo antes de abandonar el campamento o antes de retirarse a pasar la noche.

39. Tenga mucho cuidado al usar linternas o calentadores que funcionan con combustible dentro de una tienda de campaña y use linternas que funcionen con baterías siempre que sea posible. No reposte lámparas, calentadores o estufas dentro de una tienda de campaña. Apague o apague todas las linternas antes de ir a dormir.

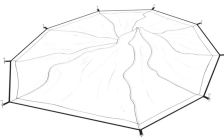
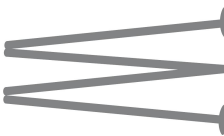
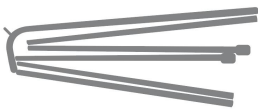
40. No fume en una tienda de campaña ni almacene líquidos inflamables dentro de una tienda de campaña. La instalación de estufas de leña o equipos de calefacción corre por su cuenta y riesgo.



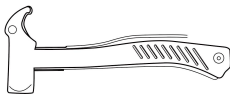
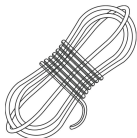

GUARDA ESTAS INSTRUCCIONES



Modelo : ZJTM1009 (diámetro : 3 m)			
PARTES LISTA			
NO.	NOMBRE	DIBUJO	CANTIDAD
1	Pabellón		1
2	poste central		1
3	Marco en A poste de la puerta		1
4	Estaca A		10

5	Estaca B		10
6	Martillo		1
7	cuerda tensora		10
8	gorro de lluvia		1

Modelo : ZJTM1149 (diámetro : 4 m)

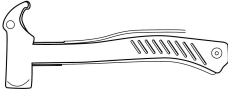
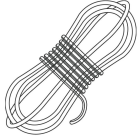

PARTES LISTA



NO.	NOMBRE	DIBUJO	CANTIDAD
1	Pabellón		1
2	poste central		1
3	Marco en A poste de la puerta		1
4	Estaca A		12

5	Estaca B		12
6	Martillo		1
7	cuerda tensora		12
8	gorro de lluvia		1

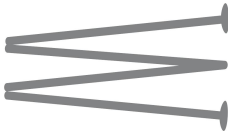
Modelo : ZJTM1215 (Diámetro : 5 m)

PARTES LISTA

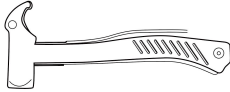
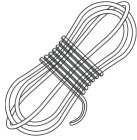

NO.	NOMBRE	DIBUJO	CANTIDAD
1	Pabellón		1
2	poste central		1
3	Marco en A poste de la puerta		1
4	Estaca A		12

5	Estaca B		12
6	Martillo		1
7	cuerda tensora		12
8	gorro de lluvia		1

Modelo : ZJTM1303 (diámetro : 6 m)

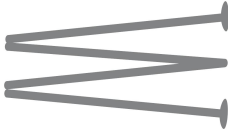
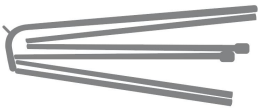
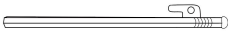

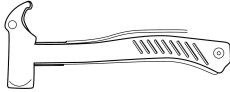
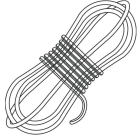

PARTES LISTA

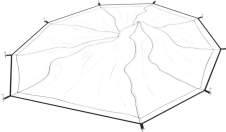

NO.	NOMBRE	DIBUJO	CANTIDAD
1	Pabellón		1
2	poste central		1
3	Marco en A poste de la puerta		1
4	Estaca A		14

5	Estaca B		14
6	Martillo		1
7	cuerda tensora		14
8	gorro de lluvia		1

Modelo : ZJTM1304 (diámetro : 7 m)

PARTES LISTA

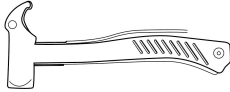
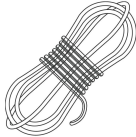
NO.	NOMBRE	DIBUJO	CANTIDAD
1	Pabellón		1
2	poste central		1
3	Marco en A poste de la puerta		1
4	Estaca A		dieciséis

5	Estaca B		dieciséis
6	Martillo		1
7	cuerda tensora		dieciséis
8	gorro de lluvia		1

INSTRUCCIONES DE ENSAMBLAJE

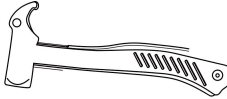
PASO 1		Arreglar el cuerpo de la tienda
<ul style="list-style-type: none"> Coloque su tienda en el suelo, mantenga el piso tenso con su compañero. <p>Sujete 10 esquinas de la tienda con la estaca B.</p>		
Estaca B	Martillo	! NOTA: Por favor, no apueste demasiado en este paso para realizar ajustes posteriores.
		

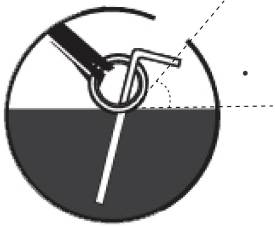
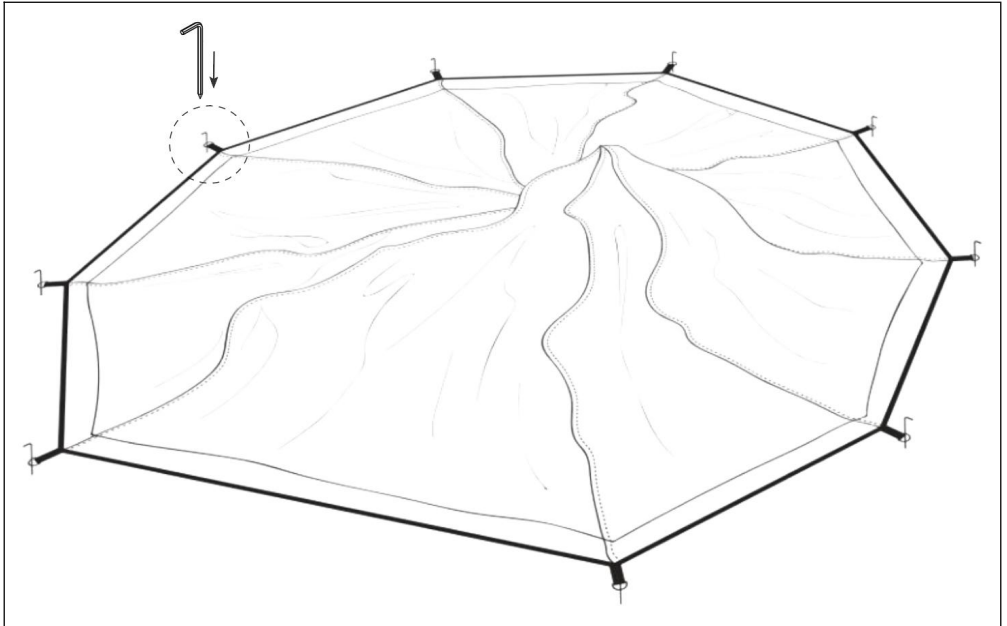

La estaca mantiene un ángulo de 45° - 60° con el suelo, por lo que el ángulo de apoyo La capacidad es la más grande.

PASO 2

Levanta la tienda

- Ensamble el poste central a través de la hebilla metálica incorporada.

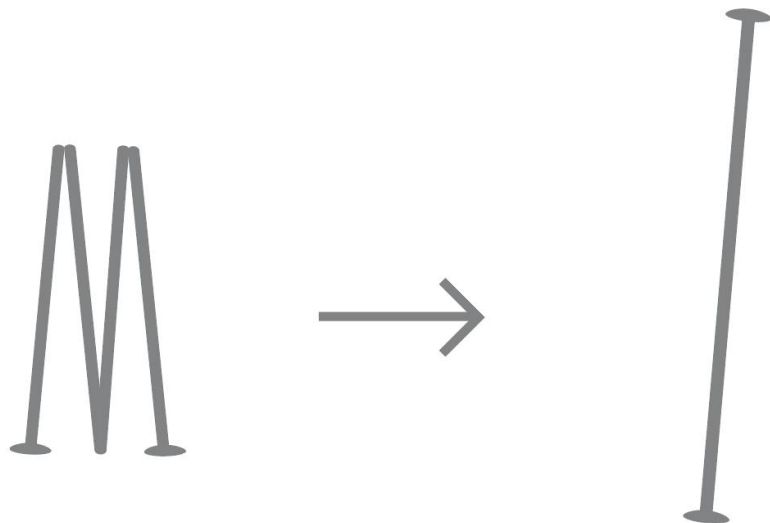

- Una persona colocó el poste central en el punto medio del piso para apuntalar la tienda.

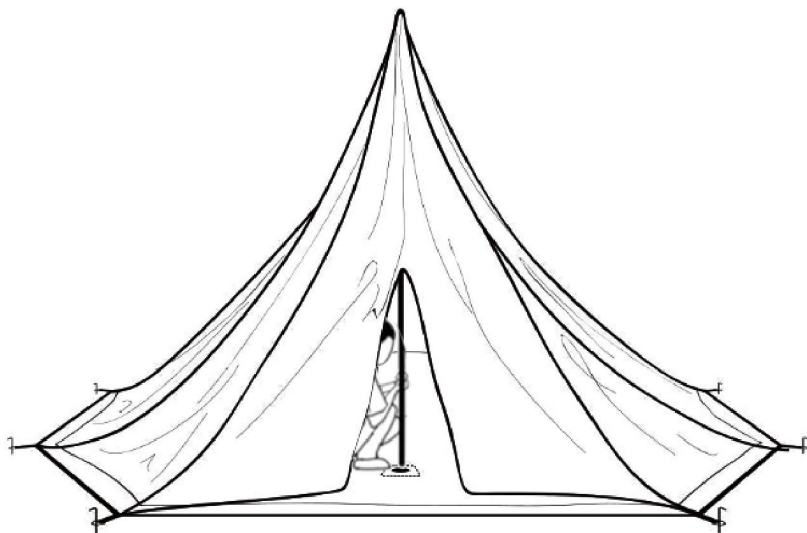

PASO 3

Instalar poste de puerta

- El compañero coloca el poste de la puerta con marco en A a través del

anillo de la parte superior de la puerta.

luego inserte las patas del poste de la puerta en los bolsillos en la parte inferior de la puerta.

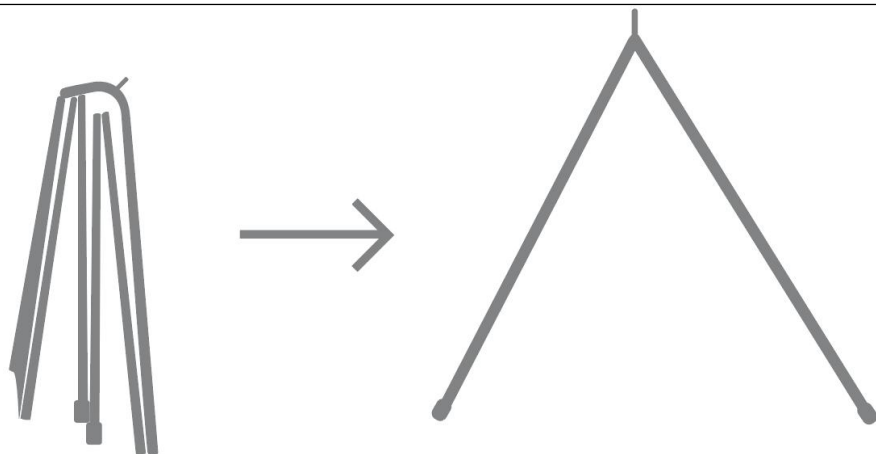

- Coloque una tapa para lluvia en la parte superior del poste de la puerta con marco en A.

(Haga ajustes a la estaca B después de este paso, si es necesario).

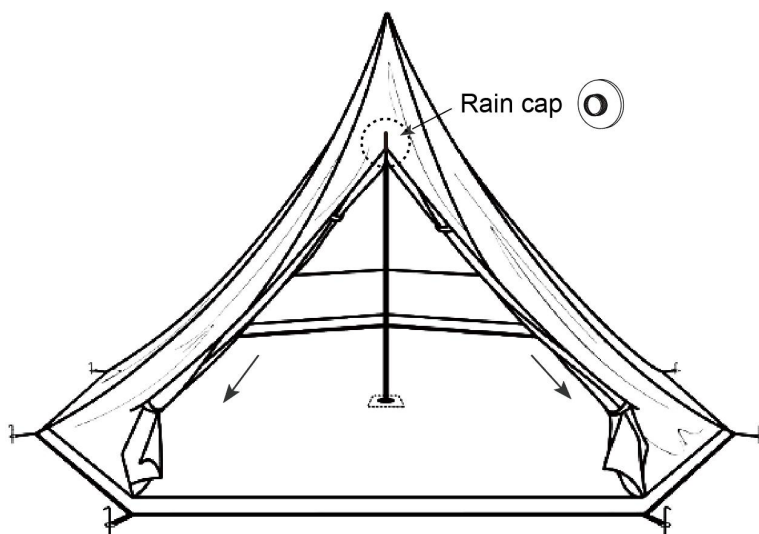

ETAPA 4

Terminar el montaje de la tienda.

- Fije 12 tensores con la estaca A alrededor de la tienda y enderécelos.

Se recomienda sacar los tensores en la dirección de cada costura en el techo de la tienda para conseguir el efecto visual y la estabilidad perfectos.

(Haga ajustes a las estacas de la tienda después de este paso, si es necesario).

Estaca A

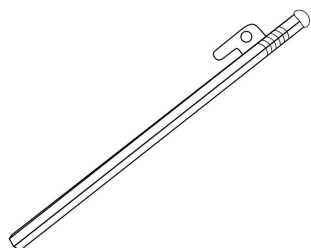

Martillo

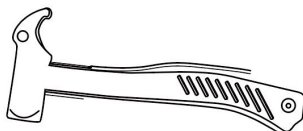

cuerda tensora

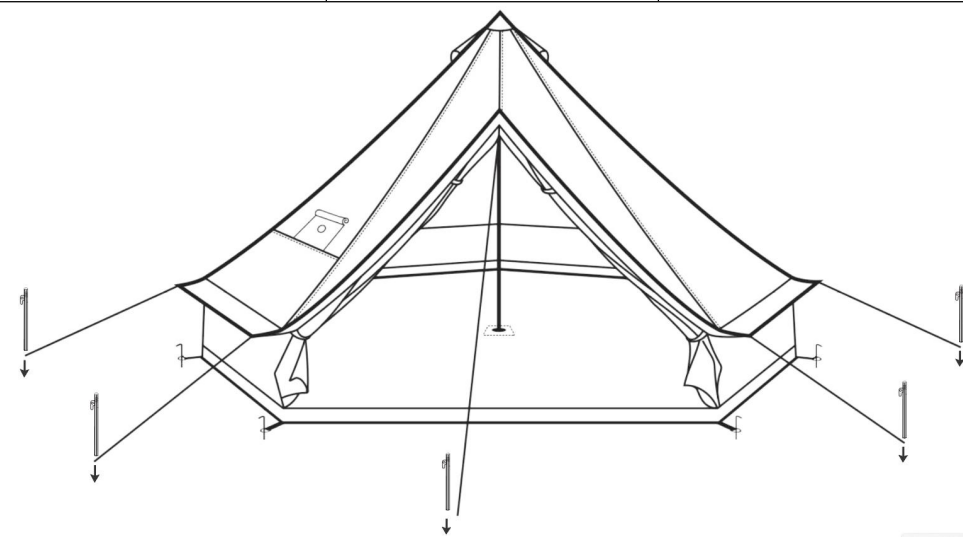
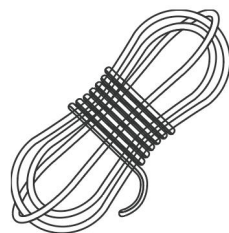

NOTA: Utilice la cuerda más larga (la hebilla de diferente color) para asegurar la puerta de la tienda.

Dirección: Baoshanqu Shuangchenglu 803long 11hao 1602A-1609shi Shanghai

Importado a AUS: SIHAO PTY LTD . 1 ROKEVA STREET ASTWOOD NSW 2122 Australia

Importado a EE. UU.: Sanven Technology Ltd.Suite 250, 9166 Anaheim Place, Rancho Cucamonga, CA 91730



SHUNSHUN GmbH
Römeräcker 9 Z2021,76351
Linkenheim-Hochstetten, Germany



Pooledas Group Ltd
Unit 5 Albert Edward House, The Pavilions
Preston, United Kingdom

Hecho en china

VEVOR[®]

TOUGH TOOLS, HALF PRICE

Técnico Certificado de soporte y garantía electrónica

www.vevor.com/support

VEVOR[®]

TOUGH TOOLS, HALF PRICE

Techniczny Certyfikat wsparcia i e-gwarancji www.vevor.com/support

JURTA NAMIOT INSTRUKCJA OBSŁUGI

We continue to be committed to provide you tools with competitive price.

"Save Half", "Half Price" or any other similar expressions used by us only represents an estimate of savings you might benefit from buying certain tools with us compared to the major top brands and does not necessarily mean to cover all categories of tools offered by us. You are kindly reminded to verify carefully when you are placing an order with us if you are actually saving half in comparison with the top major brands.

VEVOR[®]

TOUGH TOOLS, HALF PRICE

YURT TENT

Modelu: ZJTM1009, ZJTM1149, ZJTM1215, ZJTM1303, ZJTM1304

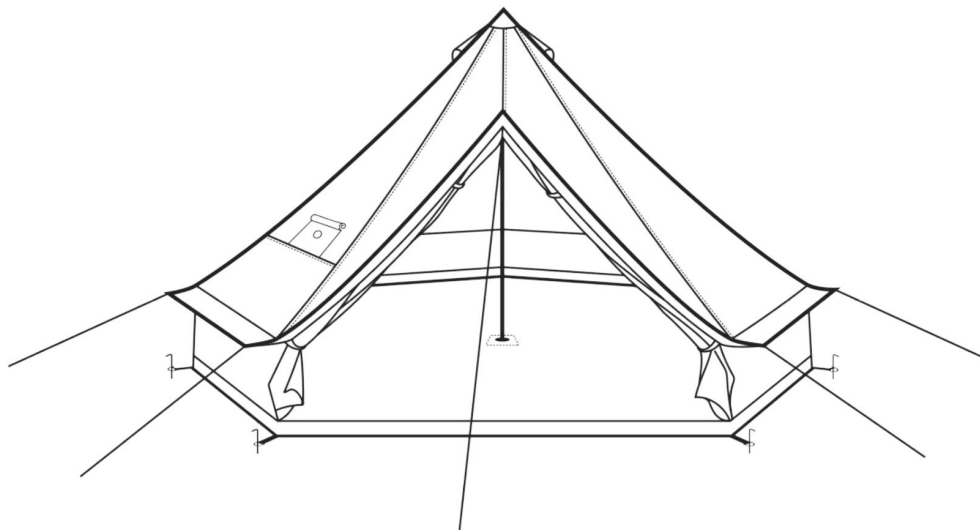

NEED HELP? CONTACT US!

Have product questions? Need technical support? Please feel free to contact us:

Technical Support and E-Warranty Certificate
www.vevor.com/support

This is the original instruction, please read all manual instructions carefully before operating. VEVOR reserves a clear interpretation of our user manual. The appearance of the product shall be subject to the product you received. Please forgive us that we won't inform you again if there are any technology or software updates on our product.

SPECYFIKACJE

Model	ZJTM1009	
Rozmiar produktu	Średnica : 3m _ Wysokość : 2m Wysokość drzwi : 1,5 m Wysokość ogrodzenia : 0,6m	
Kolor	Beżowy	

Model	ZJTM1149	
Rozmiar produktu	Średnica : 4m _ Wysokość : 2,5 m Wysokość drzwi : 1,5 m Wysokość ogrodzenia : 0,6m	
Kolor	Beżowy	

Model	ZJTM1215	
Rozmiar produktu	Średnica : 5m _ Wysokość : 3 m Wysokość drzwi : 1,7 m Wysokość ogrodzenia : 0,6m	
Kolor	Beżowy	

Model	ZJTM1303	
Rozmiar produktu	Średnica : 6m _ Wysokość : 3,5 m Wysokość drzwi : 1,7 m Wysokość ogrodzenia : 0,6m	
Kolor	Beżowy	

Model	ZJTM1304	
Rozmiar produktu	Średnica : 7m _ Wysokość : 3,5 m Wysokość drzwi : 1,9 m Wysokość ogrodzenia : 0,7m	
Kolor	Beżowy	

! OSTRZEŻENIA

26. Proszę zapoznać się z listą części, aby dokładnie sprawdzić otrzymane elementy. Nie wyrzucaj żadnego opakowania, dopóki nie sprawdzisz, czy masz wszystkie części i sprzęt! Nie wahaj się z nami skontaktować, jeśli brakuje Ci części, masz uszkodzone części lub masz inne problemy z instalacją.

27. Wybierz równe miejsce, wolne od kamieni, gałęzi i innych twardych lub ostrych przedmiotów, aby zainstalować namiot i upewnij się, że nie ma tam żadnych podziemnych instalacji. Nie ustawiaj namiotu pod drzewami lub wysokimi budynkami, aby uniknąć potencjalnych zagrożeń bezpieczeństwa spowodowanych przez spadające przedmioty.

28. Namiot został wyprodukowany do użytku jako konstrukcja tymczasowa i nie spełnia norm konstrukcyjnych. Instalator jest odpowiedzialny za przewidzenie trudnych warunków pogodowych w odpowiednim czasie montażu.

29. Ponieważ namiot wymaga naprawy na każdym etapie budowy, zapisz się pod adresem przynajmniej jedną osobę, która pomoże Ci, gdy nadejdzie czas montażu namiotu.

30. Ostrzeżenia, przestrogi i instrukcje omówione w niniejszej instrukcji obsługi nie obejmują wszystkich możliwych warunków. Nie ponosimy odpowiedzialności za jakiegokolwiek szkody spowodowane czynnikami ludzkimi. Jeśli wystąpią jakiegokolwiek problemy podczas użytkowania produktu, skontaktuj się z nami w odpowiednim czasie.

! OSTRZEŻENIE

11. Trzymaj z dala od dzieci, osób starszych i innych osób, aby zapobiec obrażeniom ciała spowodowanym przez spadające metalowe ramy podczas instalacji.

12. Trzymaj wszelkie źródła płomieni i ciepła z dala od materiału namiotu, aby uniknąć spalenia namiotu w wyniku przypadkowego kontaktu.

! INSTRUKCJA OPIEKI

11. Wyczyść gruz i utrzymuj suche płótno podczas przechowywania namiotu. Metalową ramę i płótno przechowuj oddzielnie w torbie transportowej, aby zapobiec pleśni lub uszkodzeniom.

12. Jeśli namiot jest brudny, do czyszczenia użyj zwykłego detergentu i wody.

! ŚRODKI OSTROŻNOŚCI

Wychodząc na zewnątrz należy zachować następujące środki ostrożności:

41. Upewnij się, że Twój namiot jest odpowiednio wentylowany (szczególnie jeśli zdecydujesz się zignorować pierwsze ostrzeżenie i użyć w namiocie grzejnika). Tlenek węgla istnieje naprawdę i może spowodować poważne szkody, w tym śmierć. W korpusie namiotu wbudowane są otwory wentylacyjne i ekrany.

42. Pamiętaj o prawidłowym zakotwiczeniu namiotu – nie jest to namiot wolnostojący – postępuj zgodnie z poniższymi instrukcjami dotyczącymi właściwych praktyk tyczenia i upewnij się, że wszystkie linki i kołki są bezpiecznie zamocowane.

43. Upewnij się, że dzieci w namiocie i wokół niego są przez cały czas nadzorowane.

44. Nie używaj świec, zapalek ani żadnego otwartego ognia w namiocie lub w jego pobliżu.

45. Lepiej nie gotować w namiocie, ale jeśli tak jest, nie zostawiaj gotowania bez nadzoru.

Upewnij się, że grille, urządzenia kuchenne i podobne nie mogą być umieszczane bliżej niż 1 metr od płótna namiotu. Nie należy używać otwartego ognia ani rozżarzonego węgla drzewnego wewnątrz namiotów lub w pobliżu poszycia namiotu – ogień może rozprzestrzeniać się bardzo szybko. Nie należy używać otwartego ognia ani rozżarzonego węgla drzewnego wewnątrz namiotów lub w pobliżu poszycia namiotu, ponieważ istnieje znaczne ryzyko gromadzenia się tlenku węgla (CO), szczególnie w ograniczonej



przestrzeni wewnątrz namiotu. Wszystkie elastyczne przewody i złącza palnika gazowego należy sprawdzić pod kątem wycieków i stanu technicznego.



46. Rozpalaj ogniska z wiatrem, kilka metrów od namiotu i pamiętaj o całkowitym ugaszeniu ognisk przed opuszczeniem kempingu lub przed udaniem się na noc.

47. Zachowaj szczególną ostrożność podczas korzystania z latarni lub grzejników zasilanych paliwem wewnątrz namiotu i, jeśli to możliwe, używaj latarni na baterie. Nie tankuj lamp, grzejników ani pieców wewnątrz namiotu. Przed pójściem spać zgaś lub wyłącz wszystkie latarnie.

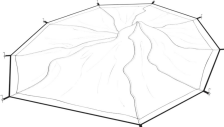
48. Nie pal w namiocie i nie przechowuj w nim łatwopalnych płynów. Montaż palników na drewno lub urządzeń grzewczych odbywa się na własne ryzyko.

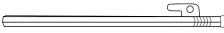

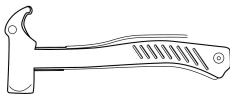
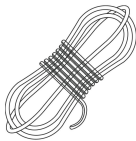

ZACHOWAJ TE INSTRUKCJE



Model : ZJTM1009 (średnica : 3 m)			
CZĘŚCI LISTA			
NIE.	NAZWA	RYSUNEK	ILOŚĆ
1	Namiot dzwonkowy		1
2	Słup środkowy		1
3	Rama A _ słupek drzwi		1
4	Stawka A		10

5	Stawka B		10
6	Młotek		1
7	Lina faceta		10
8	Czapka przeciwdeszczowa		1

Model : ZJTM1149 (średnica : 4 m)

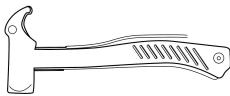
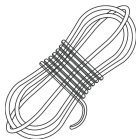

CZĘŚCI LISTA



NIE.	NAZWA	RYSUNEK	ILOŚĆ
1	Namiot dzwonkowy		1
2	Słup środkowy		1
3	Rama A _ słupek drzewi		1
4	Stawka A		12

5	Stawka B		12
6	Młotek		1
7	Lina faceta		12
8	Czapka przeciwdeszczowa		1

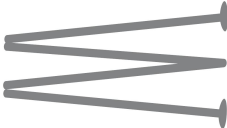
Modelka : ZJTM1215 (średnica : 5 m)

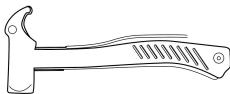
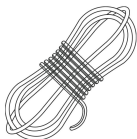

CZĘŚCI LISTA



NIE.	NAZWA	RYSUNEK	ILOŚĆ
1	Namiot dzwonkowy		1
2	Słup środkowy		1
3	Rama A _ słupek drzewi		1
4	Stawka A		12

5	Stawka B		12
6	Młotek		1
7	Lina faceta		12
8	Czapka przeciwdeszczowa		1

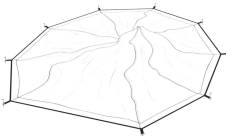
Model : ZJTM1303 (średnica : 6 m)

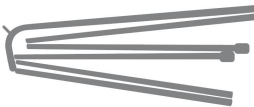
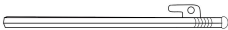

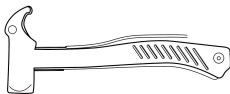
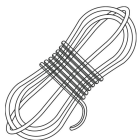
CZĘŚCI LISTA



NIE.	NAZWA	RYSUNEK	ILOŚĆ
1	Namiot dzwonkowy		1
2	Słup środkowy		1
3	Rama A _ słupek drzwi		1
4	Stawka A		14

5	Stawka B		14
6	Młotek		1
7	Lina faceta		14
8	Czapka przeciwdeszczowa		1

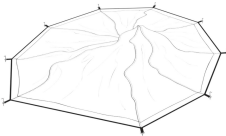
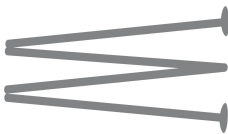
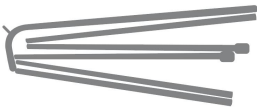
Model : ZJTM1304 (średnica : 7 m)

CZĘŚCI LISTA

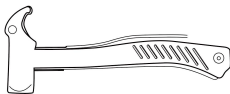
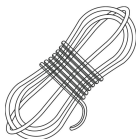
NIE.	NAZWA	RYSUNEK	ILOŚĆ
1	Namiot dzwonkowy		1
2	Słup środkowy		1
3	Rama A _ słupek drzwi		1
4	Stawka A		16

5	Stawka B		16
6	Młotek		1
7	Lina faceta		16
8	Czapka przeciwdeszczowa		1

INSTRUKCJA MONTAŻU

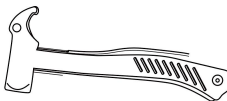
KROK 1		Napraw korpus namiotu
<ul style="list-style-type: none"> • Połóż namiot na ziemi, utrzymując podłogę napiętą razem z partnerem. <p>Zamocuj 10 rogów namiotu za pomocą kołka B.</p>		
Stawka B	Młotek	<p>! NOTATKA: Na tym etapie nie należy zbyt mocno stawiać w celu późniejszej regulacji.</p>
		

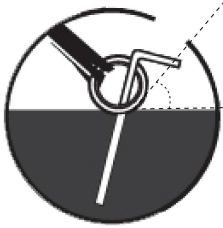
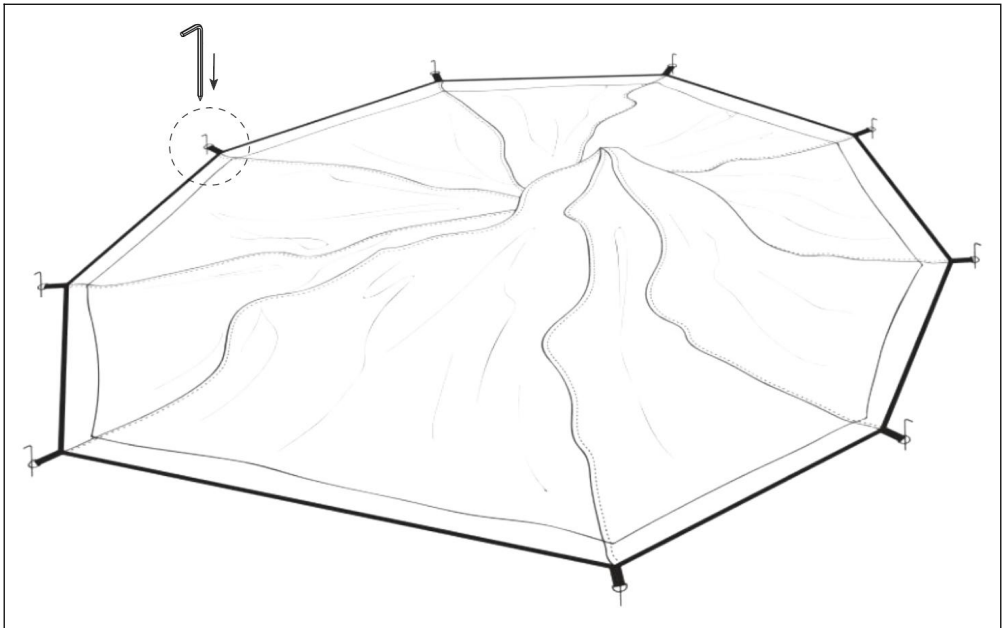

Palka utrzymuje z podłożem kąt 45° - 60° , a więc kąt podparcia pojemność jest największa.

KROK 2

Podeprzyj namiot

- Zamontuj słupek środkowy poprzez wbudowaną metalową klamrę.

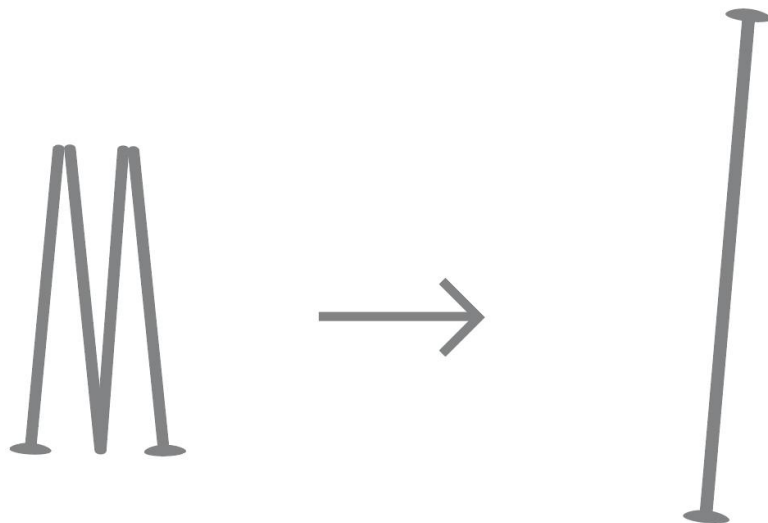

- Jedna osoba umieściła słupek środkowy na środkowym punkcie podłogi w celu podparcia namiotu.

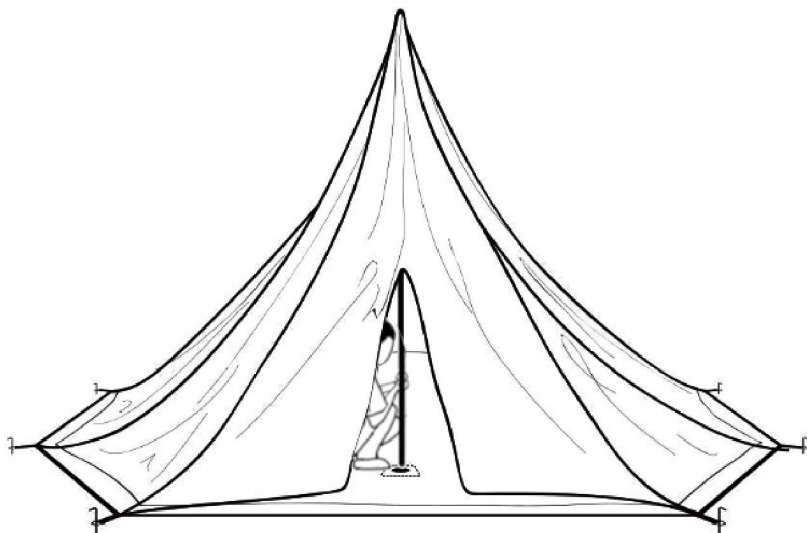

KROK 3

Zamontuj słupek drzwi

- Partner przełożył słupek drzwiowy w kształcie litery A przez pierścień u

góry drzwi,

następnie włóż nóżki słupka drzwi do kieszeni na spodniej stronie drzwi.

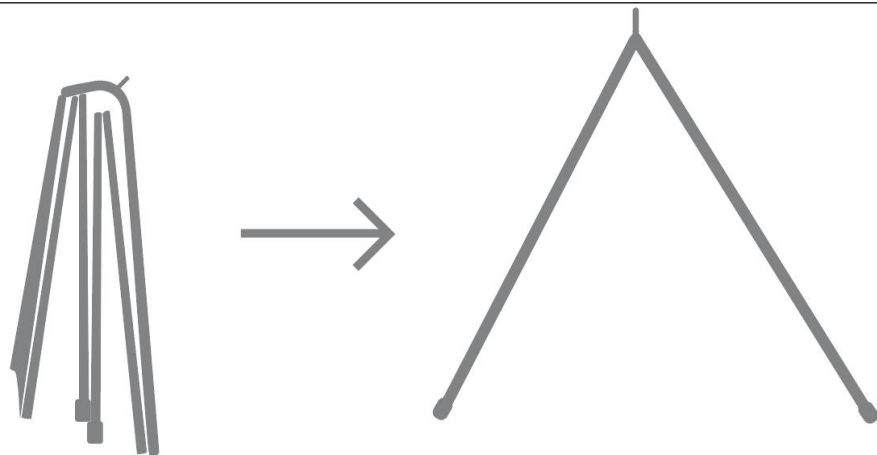

- Zamocuj osłonę przeciwdeszczową na górze słupka drzwi z ramą A.

(Jeśli zajdzie taka potrzeba, po tym kroku dokonaj regulacji kołka B.)

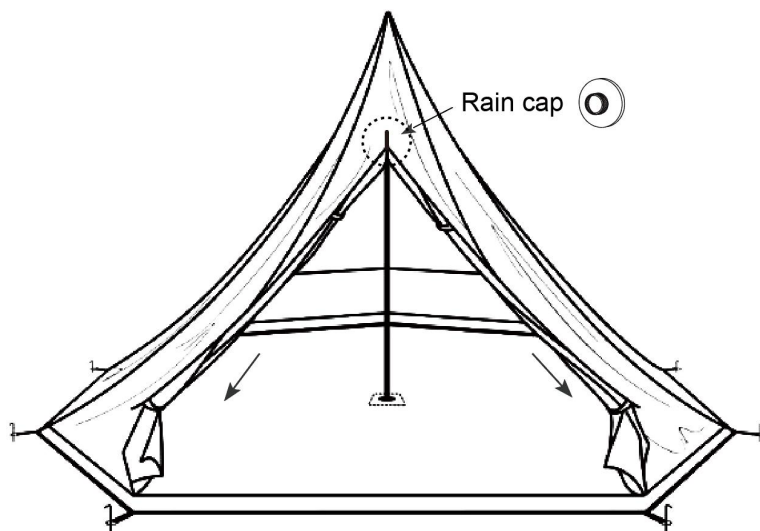

KROK 4

Zakończ montaż namiotu

- Zamocuj 12 lin odciągowych za pomocą kołka A wokół namiotu i wyprostuj je.

Zalecamy przeciągnięcie odciągów wzdłuż kierunku każdego szwu na dachu namiotu, aby uzyskać doskonały efekt wizualny i stabilność.

(W razie potrzeby po tym kroku dostosuj paliki namiotu.)

Stawka A

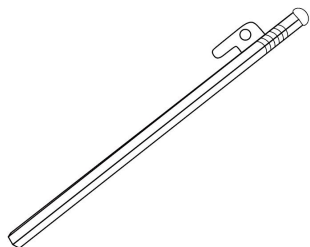

Młotek

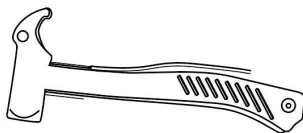

Lina faceta

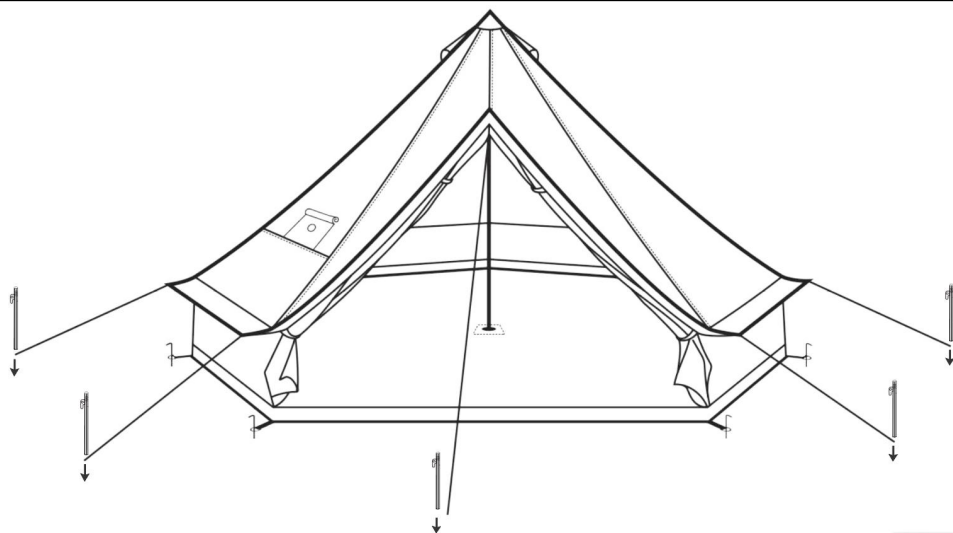
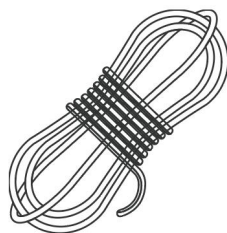

UWAGA: Użyj najdłuższej liny (klamra liny w innym kolorze), aby zabezpieczyć drzwi namiotu.

Adres: Baoshanqu Shuangchenglu 803long 11hao 1602A-1609shi Szanghaj

Import do AUS: SIHAO PTY LTD . 1 ROKEVA STREETEASTWOOD NSW 2122 Australia

Import do USA: Sanven Technology Ltd.Suite 250, 9166 Anaheim Place, Rancho Cucamonga, CA 91730



SHUNSHUN GmbH
Römeräcker 9 Z2021,76351
Linkenheim-Hochstetten,Germany



Pooledas Group Ltd
Unit 5 Albert Edward House, The Pavilions
Preston, United Kingdom

Wyprodukowano w Chinach

VEVOR[®]

TOUGH TOOLS, HALF PRICE

Techniczny Certyfikat wsparcia i e-gwarancji

www.vevor.com/support

VEVOR[®]

TOUGH TOOLS, HALF PRICE

Technisch Ondersteuning en e-garantiecertificaat www.vevor.com/support

YURT-TENT HANDLEIDING

We continue to be committed to provide you tools with competitive price.

"Save Half", "Half Price" or any other similar expressions used by us only represents an estimate of savings you might benefit from buying certain tools with us compared to the major top brands and does not necessarily mean to cover all categories of tools offered by us. You are kindly reminded to verify carefully when you are placing an order with us if you are actually saving half in comparison with the top major brands.

VEVOR®

TOUGH TOOLS, HALF PRICE

YURT TENT

Modellen: ZJTM1009, ZJTM1149, ZJTM1215, ZJTM1303,
ZJTM1304

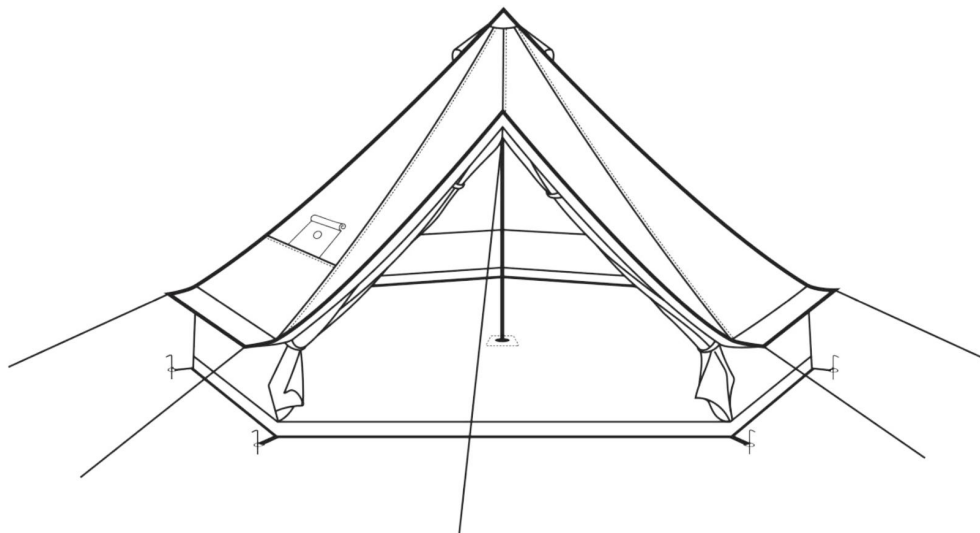

NEED HELP? CONTACT US!

Have product questions? Need technical support? Please feel free to contact us:

Technical Support and E-Warranty Certificate
www.vevor.com/support

This is the original instruction, please read all manual instructions carefully before operating. VEVOR reserves a clear interpretation of our user manual. The appearance of the product shall be subject to the product you received. Please forgive us that we won't inform you again if there are any technology or software updates on our product.

SPECIFICATIES

Model	ZJTM1009	
Product grootte	Diameter : 3m _ Hoogte : 2m Hoogte deur : 1,5 m Hoogte hek : 0,6m	
Kleur	Beige	

Model	ZJTM1149	
Product grootte	Diameter : 4m _ Hoogte : 2,5 m Hoogte deur : 1,5 m Hoogte hek : 0,6m	
Kleur	Beige	

Model	ZJTM1215	
Product grootte	Diameter : 5m _ Hoogte : 3m Hoogte deur : 1,7 m Hoogte hek : 0,6m	
Kleur	Beige	

Kleur	Beige	
-------	-------	--

Model	ZJTM1303	
Product grootte	Diameter : 6m _ Hoogte : 3,5 m Hoogte deur : 1,7 m Hoogte hek : 0,6m	
Kleur	Beige	

Model	ZJTM1304	
Product grootte	Diameter : 7m _ Hoogte : 3,5 m Hoogte deur : 1,9 m Hoogte hek : 0,7m	
Kleur	Beige	

! WAARSCHUWINGEN

31. Raadpleeg de onderdelenlijst om de items die u heeft ontvangen zorgvuldig te controleren. Gooi de verpakking niet weg totdat u hebt gecontroleerd of u over alle onderdelen en hardware beschikt! Aarzel niet om contact met ons op te nemen als u onderdelen mist, kapotte onderdelen heeft of andere installatieproblemen heeft.

32. Kies een vlakke plek uit, vrij van rotsen, takken en andere harde of scherpe voorwerpen om uw tent te installeren en zorg ervoor dat er geen ondergrondse voorzieningen aanwezig zijn. Zet uw tent niet op onder bomen of hoge gebouwen om mogelijke veiligheidsrisico's veroorzaakt door vallende voorwerpen te voorkomen.

33. De tent is vervaardigd voor gebruik als tijdelijke structuur en voldoet niet aan de structurele voorschriften. De installateur is verantwoordelijk voor het anticiperen op de weersomstandigheden voor het juiste tijdstip van installatie.

34. Omdat de tent op elk moment tijdens het bouwproces gerepareerd moet worden, kunt u zich aanmelden bij minimaal één persoon om u te helpen wanneer het tijd is om de tent op te zetten.

35. De waarschuwingen, waarschuwingen en instructies die in deze handleiding worden besproken, kunnen niet alle mogelijke omstandigheden dekken. Wij zijn niet verantwoordelijk voor schade veroorzaakt door menselijke factoren. Als er een probleem is tijdens het gebruik van het product, neem dan tijdig contact met ons op.

! WAARSCHUWING

13. Houd het apparaat uit de buurt van kinderen, ouderen en andere mensen om persoonlijk letsel veroorzaakt door vallende metalen frames tijdens de installatie te voorkomen.

14. Houd alle vlammen en warmtebronnen uit de buurt van dit tentdoek om te voorkomen dat de tent door onbedoeld contact verbrandt.

! ZORGINSTRUCTIE

13. Reinig vuil en houd het canvas droog wanneer u de tent opbergt. Bewaar het metalen frame en het canvas afzonderlijk in de draagtas om schimmel of schade te voorkomen.

14. Gebruik normaal schoonmaakmiddel en water om de tent schoon te maken als deze vuil is .

! VOORZORGSMAATREGELEN

Als u naar buiten gaat, moeten de volgende voorzorgsmaatregelen worden genomen:

49. Zorg ervoor dat uw tent goed geventileerd is (vooral als u besluit de eerste waarschuwing te negeren en een verwarming in uw tent te gebruiken). Koolmonoxide is reëel en kan ernstige schade veroorzaken, zoals de dood. Ventilatieopeningen en schermen zijn in de tentbehuizing ingebouwd.

50. Zorg ervoor dat u uw tent goed verankert – dit is geen vrijstaande tent – volg deze instructies voor de juiste uitzetpraktijken en zorg ervoor dat alle scheerlijnen en haringen stevig vastzitten.

51. Zorg ervoor dat kinderen te allen tijde onder toezicht staan in en rond de tent.

52. Gebruik geen kaarsen, lucifers of open vuur van welke aard ook in of nabij een tent.



53. Het is beter om niet in een tent te koken, maar als dat wel het geval is, laat het koken dan niet onbeheerd achter. Zorg ervoor dat grills, kooktoestellen en dergelijke niet dichter dan 1 meter bij het tentdoek worden geplaatst. Er mag geen gebruik worden gemaakt van open vuur of gloeiende houtskool in tenten of in de buurt van tentdoek - vuur kan zich zeer snel verspreiden. Er mag geen gebruik worden gemaakt van open vuur of gloeiende houtskool in tenten of in de buurt van tentdoek, aangezien er een aanzienlijk risico bestaat door de ophoping van koolmonoxide (CO), vooral in een besloten ruimte in de tent. Alle flexibele slangen en koppelingen naar de gasbrander moeten worden gecontroleerd op lekkage en in goede staat zijn.



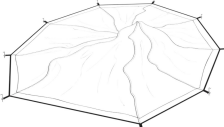

54. Bouw kampvuren met de wind mee en op enkele meters afstand van een tent en zorg ervoor dat u de kampvuren volledig dooft voordat u een camping verlaat of voordat u zich terugtrekt voor de nacht.

55. Wees uiterst voorzichtig bij het gebruik van lantaarns of verwarmingstoestellen op brandstof in een tent en gebruik waar mogelijk lantaarns die op batterijen werken. Vul geen lampen, kachels of kachels bij in een tent. Doof of schakel alle lantaarns uit voordat u gaat slapen.

56. Rook niet in een tent en bewaar geen brandbare vloeistoffen in een tent. Installatie van houtkachels of verwarmingsapparatuur is op eigen risico.

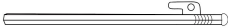
BEWAAR DEZE INSTRUCTIES

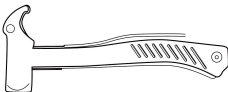
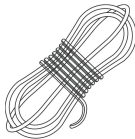



Model : ZJTM1009 (diameter : 3 m)			
ONDERDELEN LIJST			
NEE.	NAAM	TEKENING	AANTAL
1	Bellentent		1
2	Middelste paal		1

3	A-frame me e deur paal		1
4	Inzet A		10
5	Inzet B		10
6	Hamer		1
7	Kerel touw		10
8	Regenkap		1

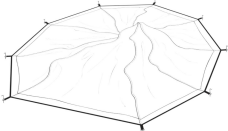
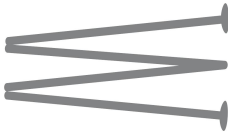
Model : ZJTM1149 (diameter : 4 m)

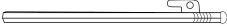
ONDERDELEN LIJST

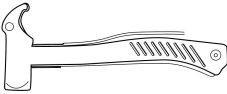
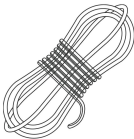



NEE.	NAAM	TEKENING	AANTAL
1	Bellentent		1
2	Middelste paal		1

3	A-frame me e deur paal		1
4	Inzet A		12
5	Inzet B		12
6	Hamer		1
7	Kerel touw		12
8	Regenkap		1

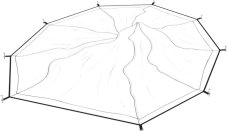
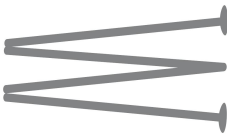
Model : ZJTM1215 (Diameter : 5 m)

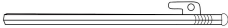

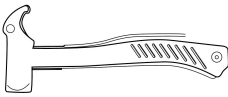
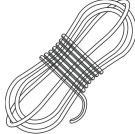
ONDERDELEN LIJST



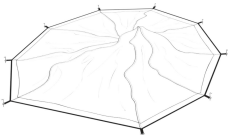

NEE.	NAAM	TEKENING	AANTAL
1	Bellentent		1
2	Middelste paal		1

3	A-frame me e deur paal		1
4	Inzet A		12
5	Inzet B		12
6	Hamer		1
7	Kerel touw		12
8	Regenkap		1

Model : ZJTM1303 (diameter : 6 m)

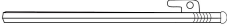

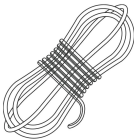
ONDERDELEN LIJST



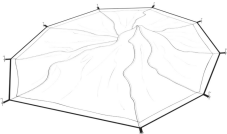

NEE.	NAAM	TEKENING	AANTAL
1	Bellentent		1
2	Middelste paal		1

3	A-frame me e deur paal		1
4	Inzet A		14
5	Inzet B		14
6	Hamer		1
7	Kerel touw		14
8	Regenkap		1

Model : ZJTM1304 (diameter : 7 m)

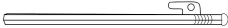
ONDERDELEN LIJST

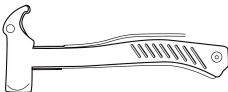
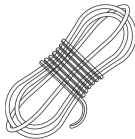
NEE.	NAAM	TEKENING	AANTAL
1	Bellentent		1
2	Middelste paal		1

3	A-frame me e deur paal		1
4	Inzet A		16
5	Inzet B		16
6	Hamer		1
7	Kerel touw		16
8	Regenkap		1

MONTAGE-INSTRUCTIES

STAP 1	Bevestig het tentlichaam	
<ul style="list-style-type: none"> • Zet je tent op de grond, houd de vloer strak met je partner. Zet 10 tenthoeken vast met de paal B. 		
Inzet B	Hamer	! OPMERKING:

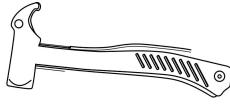

Zet bij deze stap niet teveel in op latere aanpassingen.

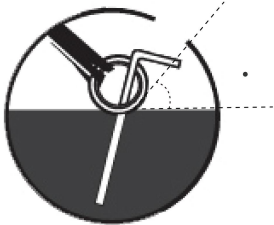
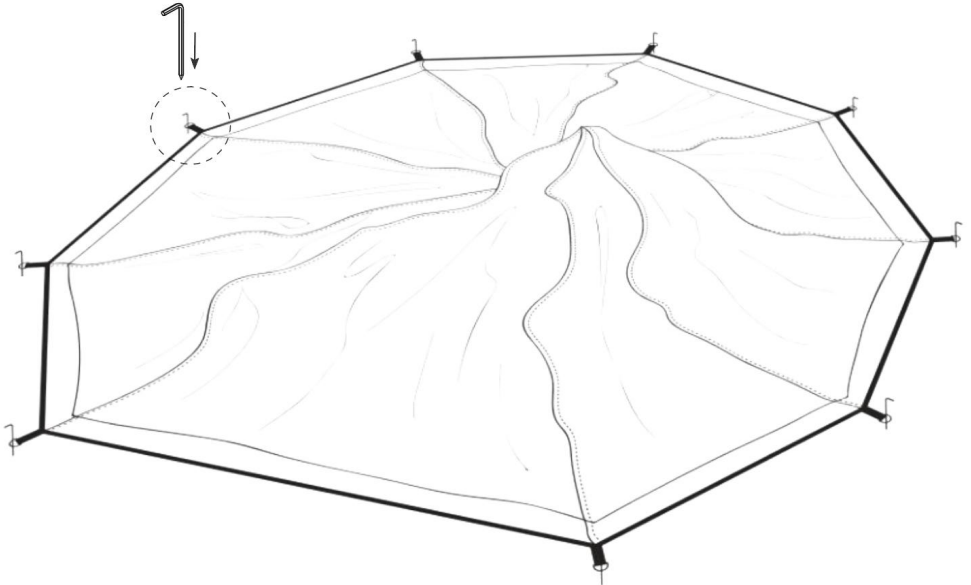

De paal behoudt een hoek van 45° - 60° met de grond, dus de steunhoek capaciteit is het grootst.

STAP 2

Zet de tent op

- Monteer de middenpaal door de ingebouwde metalen gesp.



- Eén persoon plaatste de middenpaal op het middelste punt van de vloer om de tent te ondersteunen.

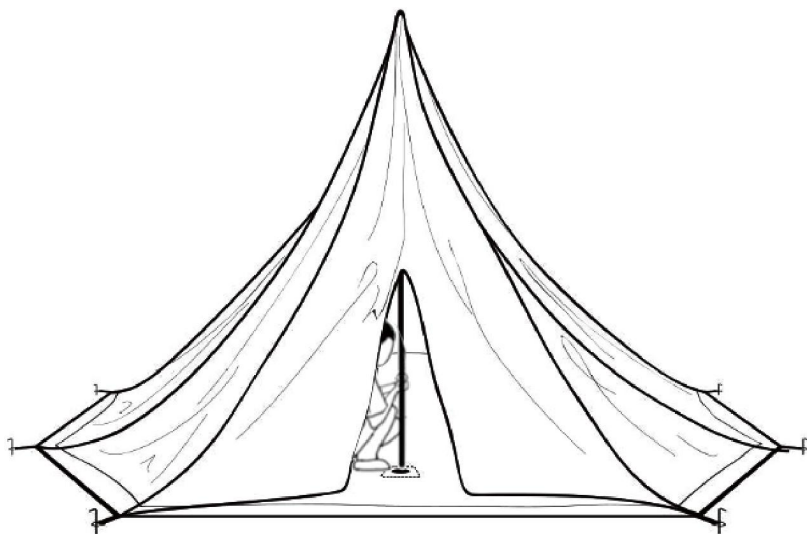

STAP 3

Deurpaal installeren

- Partner steekt deurpaal met A-frame door de ring van de deurbovenkant,

Steek vervolgens de voeten van de deurpaal in de vakken aan de onderkant van de deur.

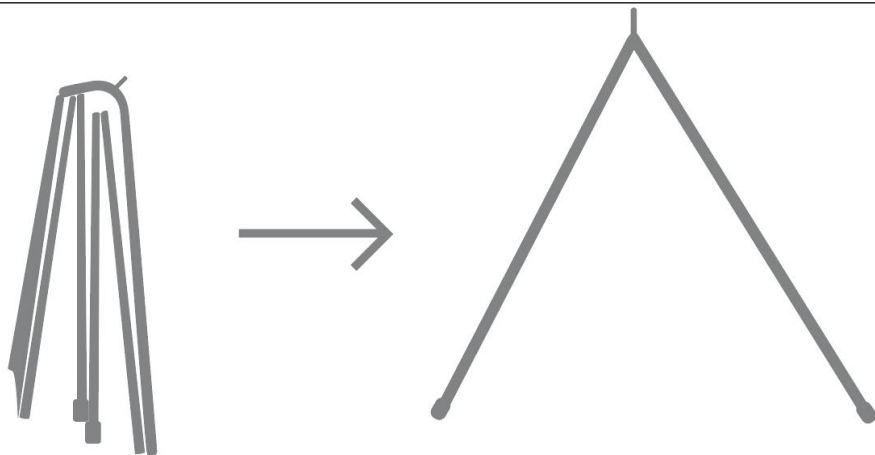

- Bevestig de regenkap op de bovenkant van de deurpaal met A-frame.

(Maak na deze stap indien nodig aanpassingen aan paal B.)

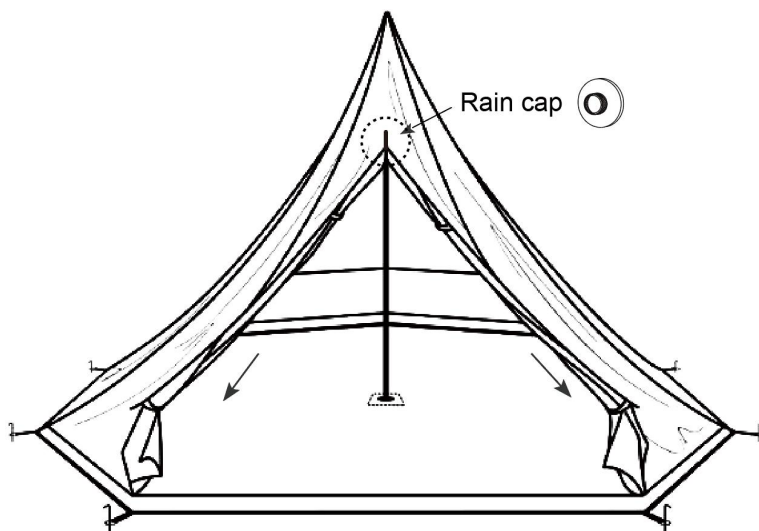

STAP 4

Voltooi de montage van de tent

- Bevestig 12 scheerlijnen met paal A rond de tent en zet ze recht.

Het wordt aanbevolen om de scheerlijnen langs de richting van elke naad uit te trekken

op het tentdak voor een perfect visueel effect en stabiliteit.

(Maak na deze stap indien nodig aanpassingen aan de tentharingen.)

Inzet A

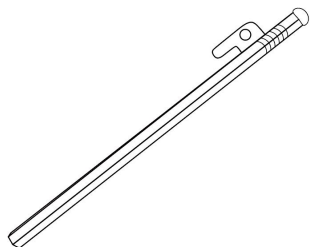

Hamer

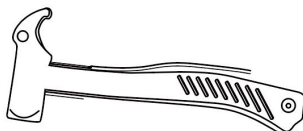

Kerel touw

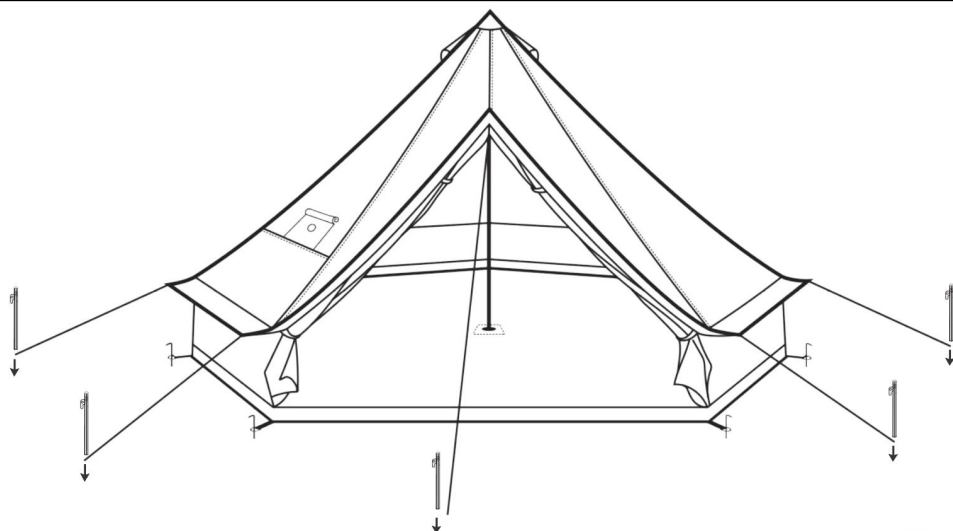
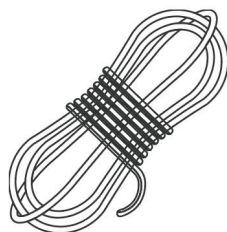

OPMERKING: Gebruik het langste touw (de touwgesp met een andere kleur) om de tentdeur vast te zetten.

Adres: Baoshanqu Shuangchenglu 803long 11hao 1602A-1609shi Shanghai

Geïmporteerd naar AUS: SIHAO PTY LTD . 1 ROKEVA STREETEASTWOOD NSW 2122
Australië

Geïmporteerd naar de VS: Sanven Technology Ltd.Suite 250, 9166 Anaheim Place,
Rancho Cucamonga, CA 91730



SHUNSHUN GmbH
Römeräcker 9 Z2021,76351
Linkenheim-Hochstetten, Germany



Pooledas Group Ltd
Unit 5 Albert Edward House, The Pavilions
Preston, United Kingdom

Gemaakt in China

VEVOR[®]

TOUGH TOOLS, HALF PRICE

Technisch Ondersteuning en e-garantiecertificaat

www.vevor.com/support

VEVOR[®]

TOUGH TOOLS, HALF PRICE

Teknisk Support och e-garanticertifikat www.vevor.com/support

JURT TÄLT ANVÄNDARMANUAL

We continue to be committed to provide you tools with competitive price.

"Save Half", "Half Price" or any other similar expressions used by us only represents an estimate of savings you might benefit from buying certain tools with us compared to the major top brands and does not necessarily mean to cover all categories of tools offered by us. You are kindly reminded to verify carefully when you are placing an order with us if you are actually saving half in comparison with the top major brands.

VEVOR®

TOUGH TOOLS, HALF PRICE

YURT TENT

Modell: ZJTM1009, ZJTM1149, ZJTM1215, ZJTM1303, ZJTM1304

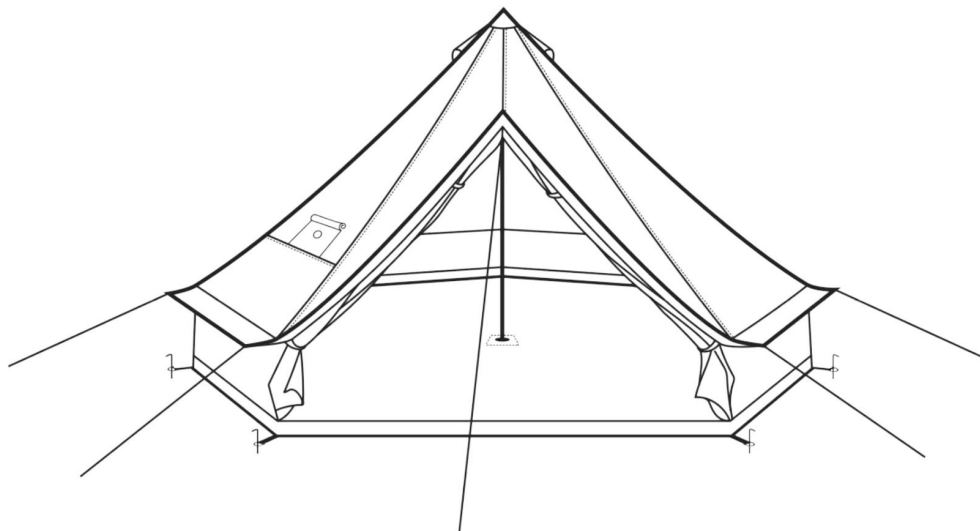

NEED HELP? CONTACT US!

Have product questions? Need technical support? Please feel free to contact us:

Technical Support and E-Warranty Certificate
www.vevor.com/support

This is the original instruction, please read all manual instructions carefully before operating. VEVOR reserves a clear interpretation of our user manual. The appearance of the product shall be subject to the product you received. Please forgive us that we won't inform you again if there are any technology or software updates on our product.

SPECIFIKATIONER

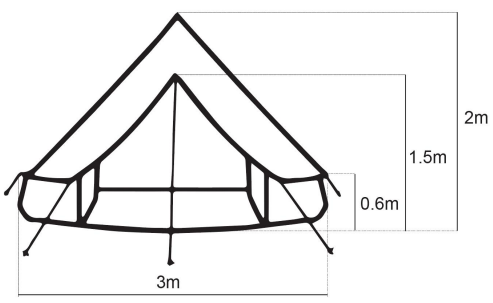
Modell	ZJTM1009	
Produktstorlek	Diameter : 3m _ Höjd : 2m Dörrhöjd : 1,5m Stängslets höjd : 0,6m	
Färg	Beige	

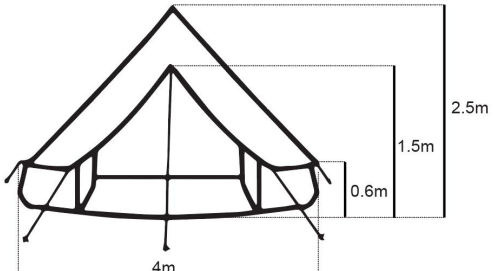
Modell	ZJTM1149	
Produktstorlek	Diameter : 4m _ Höjd : 2,5m Dörrhöjd : 1,5m Stängslets höjd : 0,6m	
Färg	Beige	

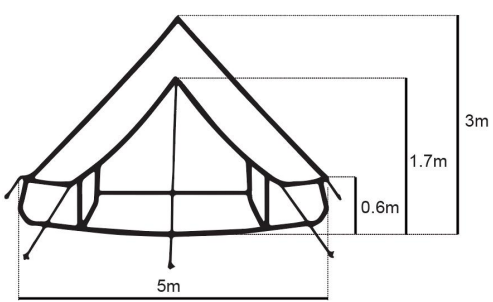
Modell	ZJTM1215	
Produktstorlek	Diameter : 5m _ Höjd : 3m Dörrhöjd : 1,7m Stängslets höjd : 0,6m	
Färg	Beige	

Modell	ZJTM1303	
Produktstorlek	Diameter : 6m _ Höjd : 3,5m Dörrhöjd : 1,7m Stängslets höjd : 0,6m	
Färg	Beige	

Modell	ZJTM1304	
Produktstorlek	Diameter : 7m _ Höjd : 3,5m Dörrhöjd : 1,9m Stängslets höjd : 0,7m	
Färg	Beige	

! FÖRSIKTIGHET

36. Se reservdelslistan för att kontrollera artiklar du fått noggrant, kassera inte något av förpackningen förrän du har kontrollerat att du har alla delar och hårdvara! Tveka inte att kontakta oss om du saknar delar , har trasiga delar eller har andra installationsproblem.

37. Välj en plan plats fri från stenar, grenar och andra hårda eller vassa föremål för att installera ditt tält och se till att inga underjordiska verktyg finns. Sätt inte upp ditt tält under träd eller höga byggnader för att undvika potentiella säkerhetsrisker orsakade av fallande föremål.

38. Tältet är tillverkat för användning som en tillfällig struktur och uppfyller inte konstruktionskoden, installatören är ansvarig för att förutse vädrets svårighetsgrad för rätt tidpunkt för installation.

39. Eftersom tältet behöver fixas när som helst under byggprocessen, mönstra kl minst en person som hjälper dig när det är dags att montera tältet.

40. De varningar, varningar och instruktioner som diskuteras i denna bruksanvisning kan inte täcka alla möjliga förhållanden. Vi kommer inte att ansvara för eventuella skador

orsakade av mänskliga faktorer. Om det uppstår några problem under användningen av produkten, vänligen kontakta oss i tid.

! VARNING

15. Håll borta från barn, äldre och andra människor för att förhindra personskador orsakade av fallande metallramar under installationen.

16. Håll alla lågor och värmekällor borta från detta tälttyg för att undvika att tältet brinner vid oavsiktlig kontakt.

! SKÖTSELINSTRUKTION

15. Rengör skräp och håll duken torr när du förvarar tältet, förvara metallramen och duken separat i väskan för att förhindra mögel eller skador.

16. Använd vanligt rengöringsmedel och vatten för rengöring om tältet är smutsigt.

! FÖRSIKTIGHETSÅTGÄRDER

Följande försiktighetsåtgärder bör vidtas när du går utomhus:

57. Se till att ditt tält är ordentligt ventilerat (särskilt om du bestämmer dig för att ignorera den första varningen och använda en värmare i ditt tält). Kolmonoxid är äkta och kan orsaka allvarliga skador såsom dödsfall. Ventilationer och skärmar är inbyggda i tältkroppen.

58. Var noga med att förankra ditt tält ordentligt - det här är inte ett fristående tält - följ dessa instruktioner för korrekt stakning och se till att alla linor och pinnar är säkert fastsatta.

59. Se till att barn är under uppsikt i och runt tältet hela tiden.

60. Använd inte ljus, tändstickor eller öppna lågor av något slag i eller nära ett tält.





61. Det är bättre att inte laga mat i ett tält, men om du är det, lämna inte matlagningen utan uppsikt. Se till att grillar, matlagningsapparater och liknande inte får placeras närmare än 1 meter från tältduken. Det bör inte användas av öppen eld eller glödande kol inuti tält eller nära tältduk - eld kan spridas mycket snabbt. Det bör inte användas av öppen eld eller glödande kol inuti tält eller nära tältduk eftersom det finns en betydande risk från ansamling av kolmonoxid (CO), särskilt i ett begränsat utrymme inuti tältet. Alla flexibla slangar och kopplingar till gasbrännaren bör kontrolleras för läckage och att de är i gott skick.

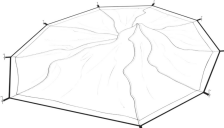

62. Bygg lägereldar i vinden och flera meter bort från ett tält och se till att släcka lägereldar helt innan du lämnar en campingplats eller innan du går i pension för natten.

63. Iaktta extrem försiktighet när du använder bränsle drivna lyktor eller värmare inuti ett tält och använd batteridrivna lyktor när det är möjligt. Tanka inte lampor, värmare eller spisar i ett tält. Släck eller stäng av alla lyktor innan du går och lägger dig.

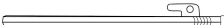
64. Rök inte i ett tält och förvara inte brandfarliga vätskor i ett tält. Installation av vedbrännare eller värmeutrustning på egen risk.

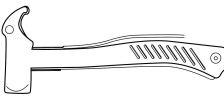

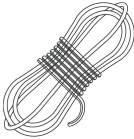

SPARA DESSA INSTRUKTIONER

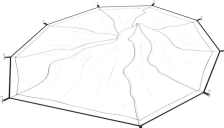

Modell : ZJTM1009 (diameter : 3m)			
DELAR LISTA			
NEJ.	NAMN	TECKNING	ANTAL
1	Bell tält		1
2	Mittstång		1
3	A-fram m e dörstång		1
4	Insats A		10
5	Insats B		10
6	Hammare		1

7	Killrep		10
8	Regnmössa		1

Modell : ZJTM1149 (diameter : 4 m)

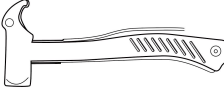

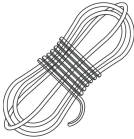

DELAR LISTA

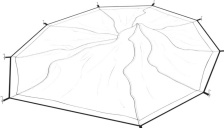

NEJ.	NAMN	TECKNING	ANTAL
1	Bell tält		1
2	Mittstång		1
3	A-ram m e dörstång		1
4	Insats A		12
5	Insats B		12
6	Hammare		1

7	Killrep		12
8	Regnmössa		1

Modell : ZJTM1215 (diameter : 5 m)

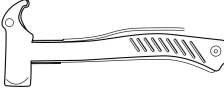

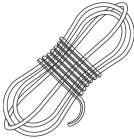

DELAR LISTA

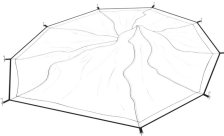

NEJ.	NAMN	TECKNING	ANTAL
1	Bell tält		1
2	Mittstång		1
3	A-ram m e dörstång		1
4	Insats A		12
5	Insats B		12
6	Hammare		1

7	Killrep		12
8	Regnmössa		1

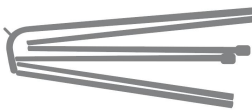
Modell : ZJTM1303 (diameter : 6 m)

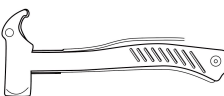

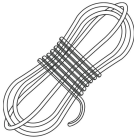

DELAR LISTA

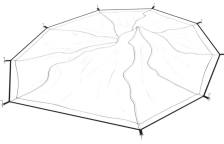

NEJ.	NAMN	TECKNING	ANTAL
1	Bell tält		1
2	Mittstång		1
3	A-ram m e dörrstång		1
4	Insats A		14
5	Insats B		14
6	Hammare		1

7	Killrep		14
8	Regnmössa		1

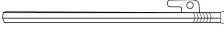
Modell : ZJTM1304 (diameter : 7 m)

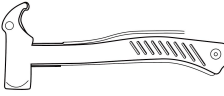
DELAR LISTA

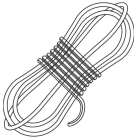
NEJ.	NAMN	TECKNING	ANTAL
1	Bell tält		1
2	Mittstång		1
3	A-ram m e dörrstång		1
4	Insats A		16
5	Insats B		16
6	Hammare		1

7	Killrep		16
8	Regnmössa		1

MONTERINGSANVISNING

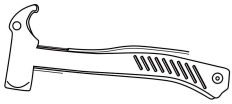
STEG 1	Fixa tältkroppen	
<ul style="list-style-type: none"> Lägg ditt tält på marken, håll golvet spänt med din partner. Stäng ner 10 tälthörn med påle B. 		
Insats B	Hammare	<p>! NOTERA: Vänligen satsa inte för mycket i detta steg för senare justering.</p>
		

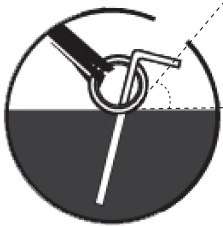
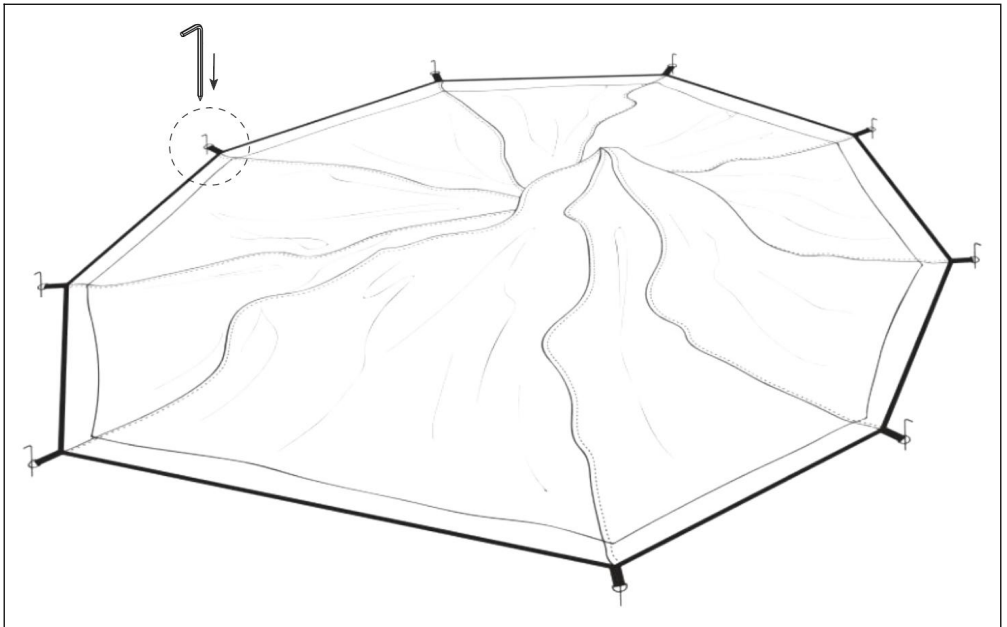

Staven bibehåller en vinkel på 45°-60° med marken, så bäringsvinkeln kapaciteten är störst.

STEG 2

Stå upp tältet

- Montera mittstången genom det inbyggda metallspännet.

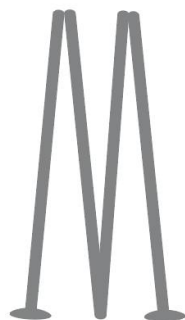

- En person satte mittstången på mitten av golvet för att stötta upp tältet.

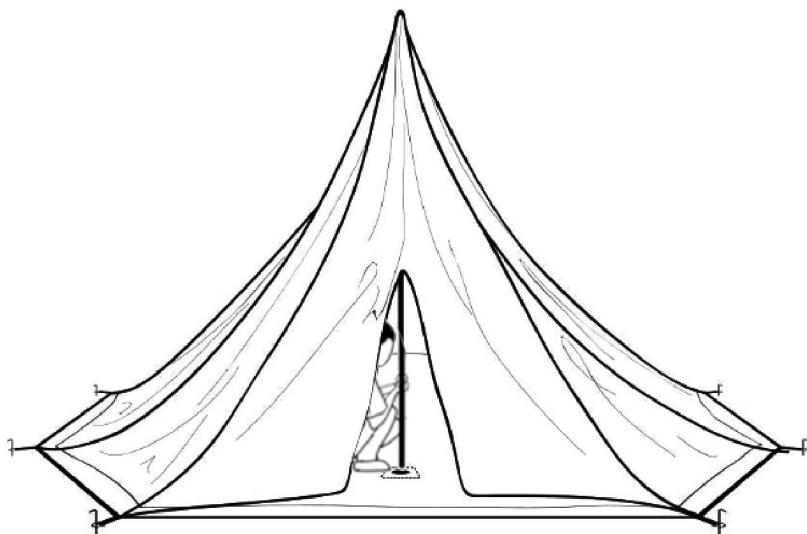

STEG 3

Montera dörrstolpen

- Partner satte A-ram dörrstång genom ringen på dörrrens topp,
Sätt sedan in fötterna på dörrstången i fickorna på undersidan av dörren.

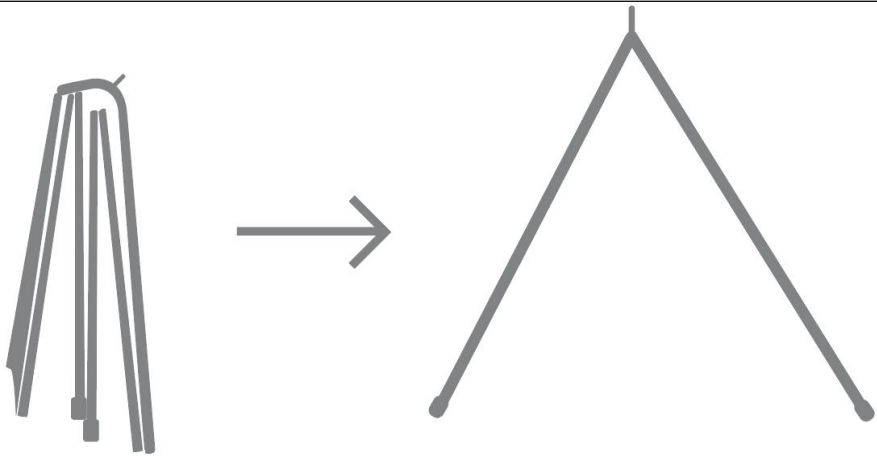

- Fäst regnskyddet på toppen av A-rams dörrstång.

(Gör justeringar av insats B efter detta steg, om det behövs.)

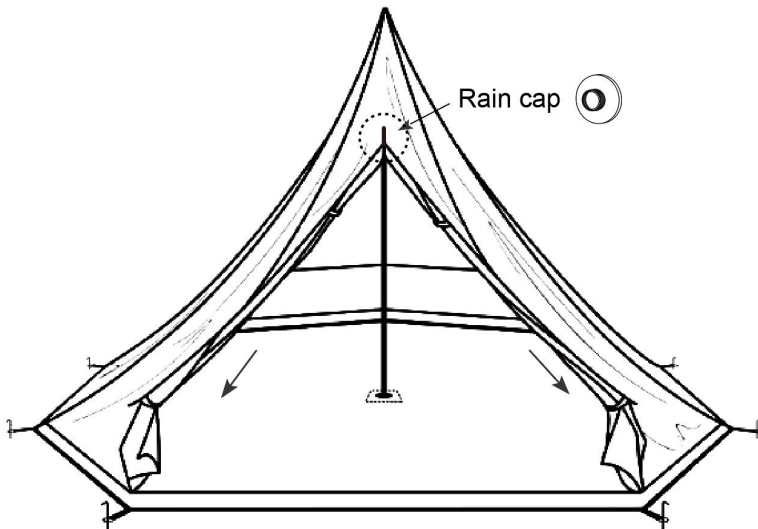

STEG 4

Avsluta monteringen av tältet

- Fäst 12 stycken rep med påle A runt tältet och räta ut dem.
Rekommenderar att dra ut draglinor längs varje söms riktning

på tälttaket för att få den perfekta visuella effekten och stabiliteten.
(Gör justeringar av tältpålarna efter detta steg, om det behövs.)

Insats A

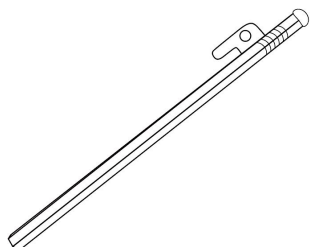

Hammare

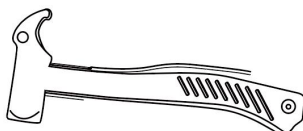

Killrep

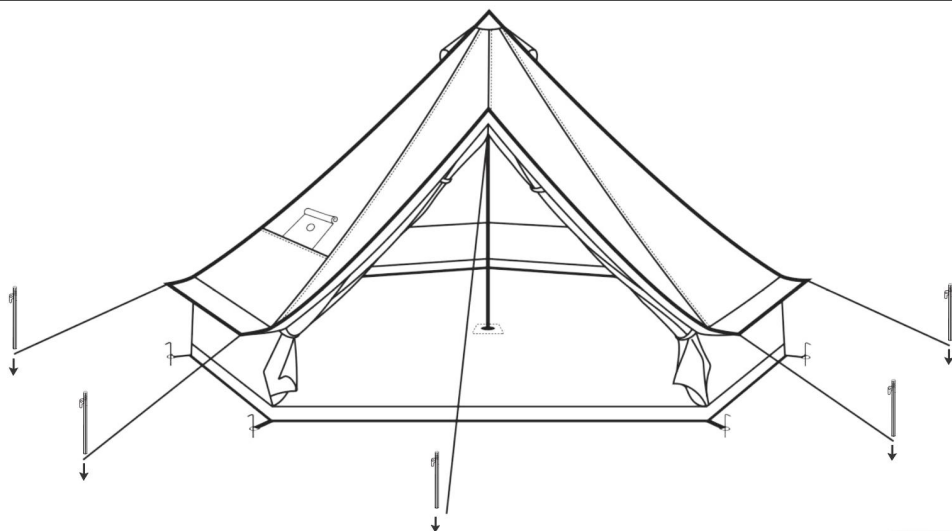
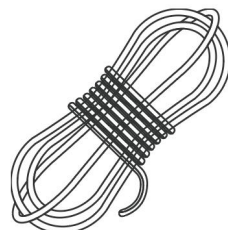

OBS: Använd det längsta repet (repspännat med annan färg) för att säkra tältdörren.

Adress: Baoshanqu Shuangchenglu 803long 11hao 1602A-1609shi Shanghai

Importerad till AUS: SIHAO PTY LTD . 1 ROKEVA STREETEASTWOOD NSW 2122
Australien

Importerad till USA: Sanven Technology Ltd.Suite 250, 9166 Anaheim Place, Rancho
Cucamonga, CA 91730

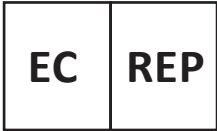

SHUNSHUN GmbH
Römeräcker 9 Z2021,76351
Linkenheim-Hochstetten, Germany



Pooledas Group Ltd
Unit 5 Albert Edward House, The Pavilions
Preston, United Kingdom

Tillverkad i Kina

VEVOR[®]

TOUGH TOOLS, HALF PRICE

Teknisk Support och e-garanticertifikat

www.vevor.com/support